



EARTHING AND LIGHTNING PROTECTION PRODUCT RANGE



RR ✓ | EARTHING ACCESSORIES



Ram Ratna International

Ram Ratna House, Oasis Complex, P. B. Marg, Worli, Mumbai - 400 013. India.

T: +91-22-2494 9009 / 2492 4144 • F: +91-22-2493 0203 / 2493 2339

E: ramratna@ramratna.com • www.ramratna.com

www.ramratna.com



RR Brand of Earthing Accessories are manufactured from Oxygen-free, Electrolytic - grade Copper. All the accessories meet the requirement of International Standards and Customer Specifications.



Since our inception, the Ram Ratna Group has strived hard to pursue simpler ideas for better living. We invest a lot of our energies to ensure that our products are easier to use and reliable. Driven by innovations, transparency and trust, we have always valued quality, better research, latest know-how, better usability and relations, developing and innovating products which truly make life easy and safe.

Our team has always thrived on the entrepreneurial and intellectual synergies across its group companies, and has encouraged associates to think and act as the owners of the business process in every market. This has significantly enhanced our ability to serve the customer better, innovate further and respond faster to the changing market needs.

The Group, with 5 factories across India and 1 in Bangladesh, is currently engaged in a range of activities which span from electricals, infrastructure, dyes and chemicals. It has an annual turnover of over 650 million.

We are a team of 2000+ highly skilled professionals, serving at our 4 manufacturing hubs and 23 marketing offices in India. Internationally, we are present in 73 countries, across 5 continents.

1. EARTHING 08

2. LIGHTNING PROTECTION 34

3. CONDUCTORS 60

4. BRASS CABLE GLANDS 74

5. COPPER CABLE LUGS 86

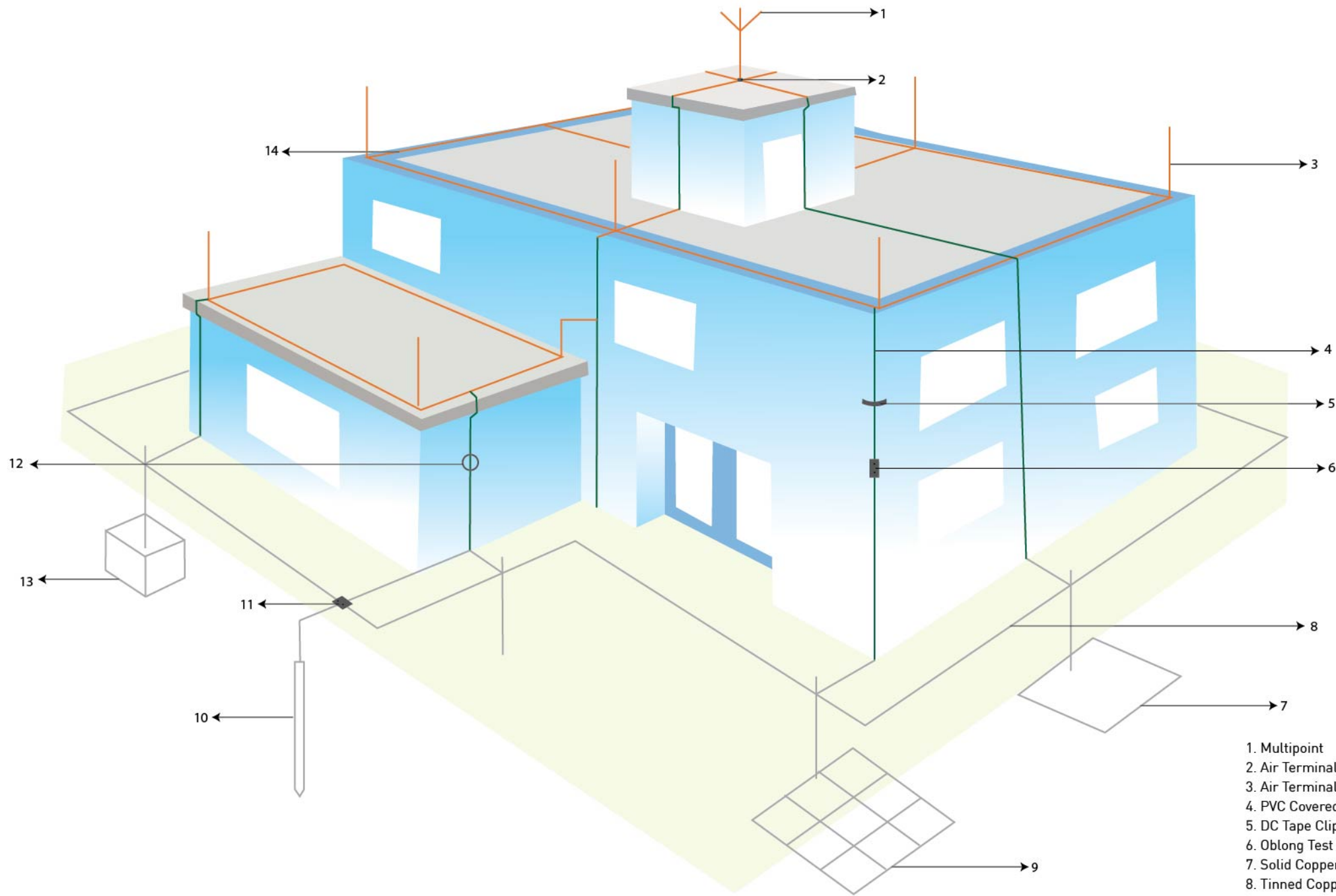

- 1. Multipoint
- 2. Air Terminal Base
- 3. Air Terminal Rod
- 4. PVC Covered Copper Tape
- 5. DC Tape Clip
- 6. Oblong Test Clamp
- 7. Solid Copper Earth Plate
- 8. Tinned Copper Tape
- 9. Lattice Copper Earth Mat
- 10. Earth Rod
- 11. Square Tape Clamp
- 12. Plate Type Test Clamp
- 13. Earth Pit
- 14. Bare Copper Tape



WE HELP EVEN THE TALLEST TOWERS TO BE GROUNDED!

An efficient earthing system is essential to ensure proper protection of personnel and equipment from the perils associated with faulty currents. If a fault within an electrical device connects a supply conductor to an exposed conductive surface, anyone touching the surface, while electrically connected to the earth, will complete a circuit back to the earthed supply conductor and receive an electric shock.

1. INTRODUCTION	10
2. EARTH RODS AND ACCESSORIES	12
3. EARTHING PRODUCTS	20
4. STATIC EARTHING PRODUCTS	33

Earthing System Design

For an efficient earthing system, it is essential that a low electrical resistance to the earth is achieved by the use of good quality conductors having sufficient cross sectional area to carry the expected current flow. The conductors used must be resistant to corrosion.

Several factors need to be considered while designing an earthing system. A complete survey, to determine the ground resistivity, is required. The chemical composition of soil, presence of certain salts and chemicals, determines the soil resistivity. Soil moisture also plays an important role in determining resistivity of soil. Excess of soil moisture reduces the resistivity. Temperature is another determining factor, since resistance is much higher on frozen ground. The survey is incomplete without details regarding the metallic framework like tanks, pipes, rails, etc, which may need to be bonded into the earthing system to prevent the danger of side flashing.

Earth Terminations

An earth electrode should be connected to each down conductor which constitutes the Lightning Protection System. An Earth Inspection Pit is required for earth rods to enable periodic inspection, testing and maintenance of earth resistance.

Resistance to earth

The maximum resistance value for an earthing system is specific to area and application. In case a single earth rod is not sufficient to achieve the required resistance, several earth rods may be used. In such case, the combined resistance of the rods is proportional to reciprocal of individual rod resistance. Normally, the minimum spacing between the rods should not be less than their driven length. In geographical locations which make it impossible to use rods of longer length, rods with larger diameter or copper earth mats and earth plates can be used. A lower resistance value can be obtained by maximising the utilization of the rods, increasing the length of the rods to drive them deeper or by using rods of a larger diameter.



Joints

A complex Lightning Protection System would involve joints and crossovers for which mechanical clamps are used. Each such clamp is a potential source of discontinuity. Hence, it should be ensured that the contact surfaces are clean and that the clamps are tightly fixed and well protected from corrosion, which could also occur if two dissimilar metals are joined. Ideally, an earthing system design should comprise of as few as joints as possible.

Life and maintenance of an earth system

Any exposed or underground earth system is subject to corrosion due to environmental conditions. Corrosion and fault currents can cause high resistance joints, which can lead to overheating. Hence, it becomes necessary to keep a periodic check on the Earth System to ensure that it retains its ability to conduct the same current carrying capacity as it did when it was installed. A properly installed and maintained earth system can last for several years.

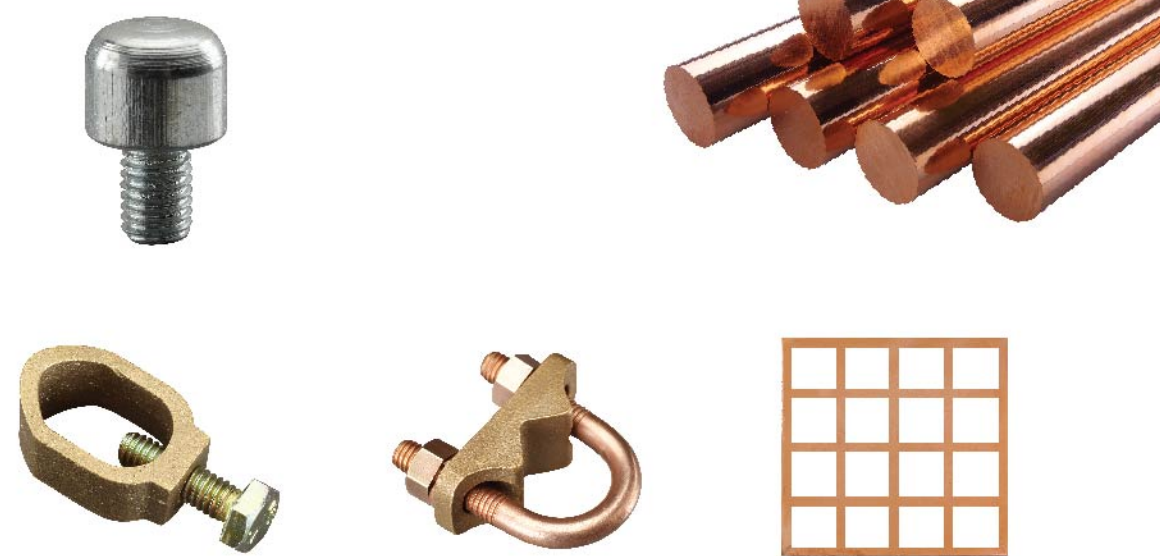

Copper Bonded Earth Rods

- Produced by electrolytically bonding steel-core with 99.95 % pure copper
- Most economical method of achieving a low earth-resistance
- Threading formed by cold rolling process (stronger than cut-threads), ensuring strength of the metallurgical bond
- Low carbon-steel-core ensures high tensile strength
- Highly corrosion resistant; ideal for deep driving
- Standard copper thickness is 0.25 mm
- Custom copper thicknesses also available

Threaded

Nominal Size	L mm	Thread Size	Shank D mm	L1 mm	Unit Weight Kg	Pack Quantity	Part Number	
1/2"	1200	9/16"	12.7	25	1.18	25	RRER 1212	
	1500				1.55	20	RRER 1215	
	1800				1.76	20	RRER 1218	
	2400				2.36	15	RRER 1224	
5/8"	1200	5/8"	14.2	25	1.49	20	RRER 1412T	
	1500				1.86	15	RRER 1415T	
	1800				2.98	15	RRER 1418T	
	2400				2.23	10	RRER 1424T	
	3000		3.72	10	RRER 1430T			
	1200		16mm	14.0	25	1.89	15	RRER 1612
	1500					2.36	15	RRER 1615
	1800					2.84	10	RRER 1618
	2400	3.78				10	RRER 1624	
	3000	4.73		8	RRER 1630			
	1200	16mm		14.0	25	1.45	20	RRER 1412
	1500					1.81	15	RRER 1415
	1800					2.17	15	RRER 1418
	2400		2.90			10	RRER 1424	
	3000	4.00	8	RRER 1430				
	3/4"	1200	3/4"	17.2	30	2.19	15	RRER 1712
1500		2.73				15	RRER 1715	
1800		3.27				10	RRER 1718	
2400		4.35				5	RRER 1724	
3000		5.44				5	RRER 1730	

Material: Pure copper molecularly bonded onto a steel core

Unthreaded

Nominal Size	L mm	Shank D mm	Unit Weight Kg	Pack Quantity	Part Number
3/8"	1200	9.5	0.62	5	RRERB 3812

Material: Pure copper molecularly bonded onto a steel core



Threaded Couplings

- High-strength couplings, used for joining copperbond threaded earth rods together
- Manufactured from a high copper content alloy, ensuring excellent corrosion resistance
- Protect threads during installation
- Ensure continual contact between the rods, during and after installation
- Facilitate deep driving
- Lead-in for ease of assembly
- Available in hexagonal and round designs



Type Thread	L mm	D mm	Unit Weight Kg	Pack Quantity	Part Number
1/2"	50	15.5	0.035	25	RRCPLR 1250
1/2"	60	15.5	0.043		RRCPLR 1260
1/2"	70	15.5	0.049		RRCPLR 1270
5/8"	50	18.5	0.041		RRCPLR 5850
5/8"	60	18.5	0.048		RRCPLR 5860
5/8"	70	18.5	0.056		RRCPLR 5870
16 MM	50	18.5	0.041		RRCPLR 1650
16 MM	60	18.5	0.048		RRCPLR 1660
16 MM	70	18.5	0.056		RRCPLR 1670
3/4"	50	23.0	0.057		RRCPLR 3450
3/4"	60	23.0	0.082		RRCPLR 3460
3/4"	70	23.0	0.098		RRCPLR 3470

Material: Brass / Gunmetal

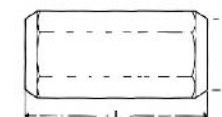

Threaded Driving Heads

- Screw into threaded couplings to allow deep driving of the earth rods
- Suitable for driving copperbond threaded earth rods by hand or with a power hammer
- Re-usable



Type	L mm	D mm	Unit Weight Kg	Pack Quantity	Part Number
1/2"	50	20	0.05	25	RRDH 1/2
5/8"	55	22	0.08		RRDH 5/8
3/4"	60	25	0.13		RRDH 3/4

Material: Steel

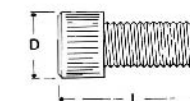



Solid Copper Earth Rods

- Produced from Electrolytic Grade Copper
- Internally threaded for jointing
- Highly corrosion resistant
- Exceptionally long life

Shank D mm	L mm	Thread Size	L1 mm	Unit Weight Kg.	Pack Quantity	Part Number
12	1200	M8	20	1.21	10	RRSER 1212
	1500			1.51		RRSER 1215
13.5	1200	M10	20	1.52	10	RRSER 1312
	1500			1.90		RRSER 1315
15	1200	M10	20	1.88	10	RRSER 1512
	1500			2.35		RRSER 1515
16	1500	M10	20	2.66	5	RRSER 1615
	1800			3.20		RRSER 1618
	2400			4.28		RRSER 1624
	3000			5.36		RRSER 1630
20	1200	M10	20	3.34	5	RRSER 2012
	1500			4.18		RRSER 2015
	1800			5.03		RRSER 2018
	2400			6.71		RRSER 2024
25	3000	M12	25	8.40	3	RRSER 2030
	1200			5.23		RRSER 2512
	1500			6.54		RRSER 2515
	1800			7.86		RRSER 2518
	2400			10.50		RRSER 2524
	3000	13.10	RRSER 2530			

Material: Copper to BS EN 13601

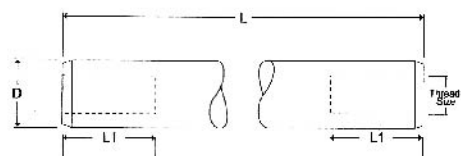

ERCS 16



ERCS 16



ERD 16



Driving Heads

- Protects internal thread
- Protects top of rod when being driven into the ground
- Made as per diameter and thread of the rods

D mm	L mm	Thread Size	L1 mm	Unit Weight Kg.	Pack Quantity	Part Number
16	48	M10	20	0.03	25	RRDH 16
20	41	M10	20	0.06		RRDH 20
25	45	M12	25	0.10		RRDH 25

Material: Steel

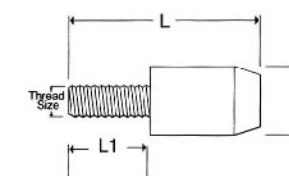

Driving Spikes

- Enable the rods to be driven easily into the ground
- Made as per diameter and thread of the rods

D mm	L mm	Thread Size	L1 mm	Unit Weight Kg.	Pack Quantity	Part Number
16	48	M10	20	0.03	25	RRDT 16
20	41	M10	20	0.06		RRDT 20
25	45	M12	25	0.10		RRDT 25

Material: Steel

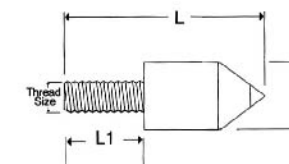

Coupling Dowels

- Coupling dowels are used to join solid copper earth rods together
- Ensures there is no broken contact

Thread Size	L mm	Unit Weight Kg.	Pack Quantity	Part Number
M10	40	0.02	25	RRDWP 10
M12	50	0.04		RRDWP 12

Material: Brass / Copper

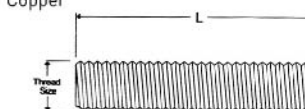

Stainless Steel Earth Rods

- Produced from stainless steel
- Internally threaded for jointing
- Highly corrosion resistant
- Designed to prevent galvanic corrosion caused by dissimilar metals being buried in close proximity

Shank D mm	L mm	Thread Size	L1 mm	Unit Weight Kg.	Pack Quantity	Part Number
16	1200	M10	20	1.87	10	RRSSER 1612
	1500			2.35		RRSSER 1615
	1800			2.83		RRSSER 1618
	2400			3.79	7	RRSSER 1624
	3000			4.75	RRSSER 1630	
20	1200	M10	20	2.95	10	RRSSER 2012
	1500			3.71	RRSSER 2015	
	1800			4.46	7	RRSSER 2018
	2400			5.96	5	RRSSER 2024
	3000			7.46	RRSSER 2030	
25	1200	M10	20	4.64	5	RRSSER 2512
	1500			5.81		RRSSER 2515
	1800			6.99	3	RRSSER 2518
	2400			9.34	RRSSER 2524	
	3000			11.69	RRSSER 2530	

Material: Material: Stainless Steel to BS EN 10088

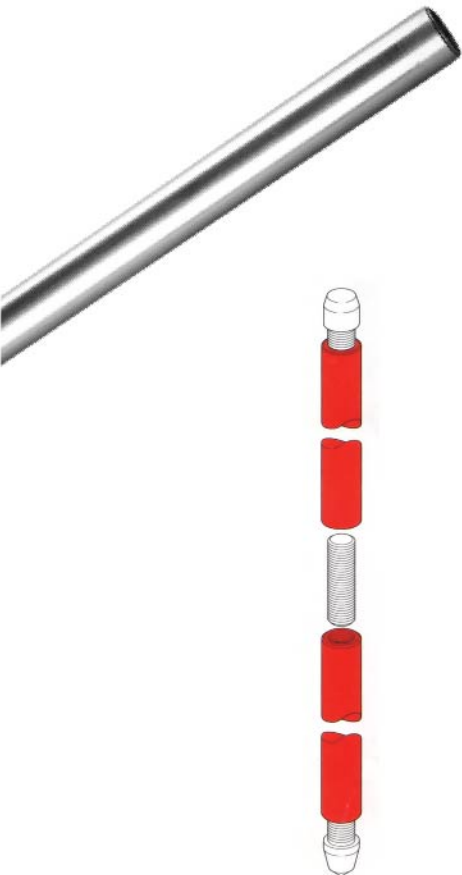
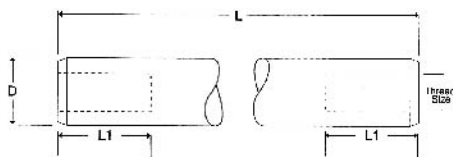

Driving Heads

- Protect internal thread
- Protect the top of the rod when being driven into the ground
- Made as per diameter and thread of the rods

D mm	L mm	Thread Size	L1 mm	Unit Weight Kg.	Pack Quantity	Part Number
16	48	M10	20	0.03		RRDH 16
20	41	M10	20	0.06	25	RRDH 20
25	45	M12	25	0.10		RRDH 25

Material: Steel

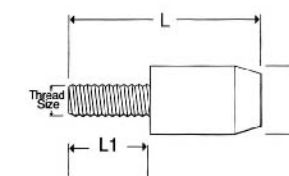

ERCS 16

Driving Spikes

- Enable the rods to be driven easily into the ground

D mm	L mm	Thread Size	L1 mm	Unit Weight Kg.	Pack Quantity	Part Number
16	48	M10	20	0.03		RRDT 16
20	41	M10	20	0.06	25	RRDT 20
25	45	M12	25	0.10		RRDT 25

Material: Steel

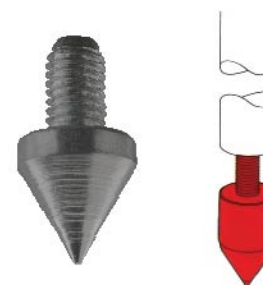
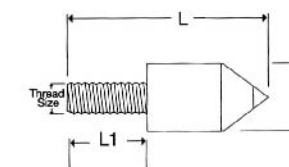

ERCS 16

Coupling Dowels

- Stainless steel coupling dowels are used to join stainless steel earth rods together
- Ensures there is no broken contact

Thread Size	L mm	Unit Weight Kg.	Pack Quantity	Part Number
M10	40	0.02		RRDWP 10
M12	50	0.04	25	RRDWP 12

Material: Stainless Steel

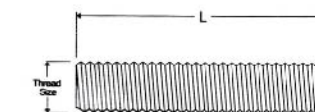

ERD 16

Galvanised Steel Earth Rod

- Produced by hot-dip galvanising machined steel rod with a coating of zinc not less than 90 microns
- Male and female threading at opposite ends, enabling two rods to be joined together
- Supplied as standard set, complete with toughened steel driving head and hardened steel driving spike

Nominal Size	L mm	Thread Size (BSF)	D mm	L1 mm	L2 mm	Unit Weight Kg.	Pack Quantity	Part Number
5/8"	1200	3/4"	16.5 - 17.0	30	25	2.1	5	RRGSE 5812

Material: Mild Steel galvanised to BS EN ISO 1461

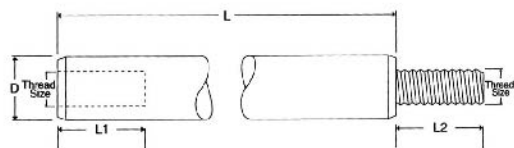

Earth Rod to Tape 'A' Clamps

- Aluminium Bronze with M10 x 25mm Phosphor Bronze Set Screw
- Used for joining earth rods to different sizes of copper tape
- Highly corrosion resistant
- Mechanically strong, ensuring lasting connection

Earth Rod Shank D mm	Maximum Tape Size mm	L mm	W mm	H mm	Unit Weight Kg.	Pack Quantity	Part Number
12.7	26 x 15	43	37	17	0.1	50	RRCMPA 1226
	32 x 15	43	45	18	0.2	30	RRCMPA 1232
	39 x 15	44	51	22	0.25	30	RRCMPA 1239
14.2	26 x 14	43	37	17	0.1	50	RRCMPA 1426
	32 x 14	43	45	18	0.2	30	RRCMPA 1432
	39 x 14	44	51	22	0.25	30	RRCMPA 1439
15.0	26 x 16	47	64	20	0.21	20	RRCMPA 1451
	26 x 13	43	37	17	0.1	50	RRCMPA 1526
	32 x 13	43	45	18	0.2	30	RRCMPA 1532
16.0	39 x 13	44	51	22	0.25	30	RRCMPA 1539
	51 x 15	47	64	20	0.21	20	RRCMPA 1551
	26 x 12	43	37	17	0.1	50	RRCMPA 1626
17.2	32 x 12	43	45	18	0.2	30	RRCMPA 1632
	39 x 12	44	51	22	0.25	30	RRCMPA 1639
	51 x 14	47	64	20	0.21	20	RRCMPA 1651
20.0	26 x 11	43	37	17	0.1	50	RRCMPA 1726
	32 x 11	43	45	18	0.2	30	RRCMPA 1732
	39 x 11	44	51	22	0.25	30	RRCMPA 1739
20.0	51 x 12.5	47	64	20	0.21	20	RRCMPA 1751
	26 x 8	43	37	17	0.1	50	RRCMPA 2026
	32 x 8	43	45	18	0.2	30	RRCMPA 2032
20.0	39 x 8	44	51	22	0.25	30	RRCMPA 2039
	51 x 10	47	64	20	0.21	20	RRCMPA 2051

Material: Brass and Gunmetal

- Aluminium with M10 x 25mm Stainless Steel Set Screw
- Used mainly for connecting aluminium tape to a puddle flange rod, as part of Lightning Protection System

Rod Shank D mm	Maximum Tape Size mm	L mm	W mm	H mm	Unit Weight Kg.	Pack Quantity	Part Number
16	26 x 12	44	40	19	0.6	25	RRCMPA 1625A

Material: Aluminium with M10x25mm Stainless Steel set screw

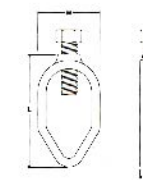
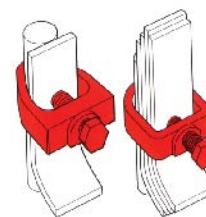

Earth Rod to Cable 'G' Clamps

- Used for joining earth rods to different sizes of stranded copper conductor
- Highly corrosion resistant
- Mechanically strong, ensuring lasting connection

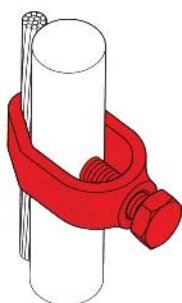
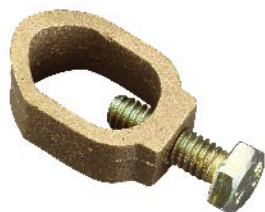

Earth Rod Shank D mm	Conductor Range mm ²	L mm	W mm	H mm	Unit Weight Kg.	Pack Quantity	Part Number
9.5	6 - 35	32	20	16	0.04	30	RRCMPG 9535
12.7	6 - 35	34	25	15	0.05	30	RRCMPG 1235
	35 - 70	41	25	17	0.08	50	RRCMPG 1270
14.2	6 - 16	34	25	15	0.05	30	RRCMPG 1416
	16 - 70	41	25	17	0.08	50	RRCMPG 1470
	70 - 185	47	30	18.5	0.1	50	RRCMPG 1418
15.0	6 - 16	34	25	15	0.05	30	RRCMPG 1516
	16 - 70	41	25	17	0.08	50	RRCMPG 1570
	70 - 150	47	30	18.5	0.1	50	RRCMPG 1550
16.0	6 - 70	41	25	17	0.08	50	RRCMPG 1670
	70 - 120	47	30	18.5	0.1	50	RRCMPG 1612
17.2	6 - 95	47	30	18.5	0.1	50	RRCMPG 1795
20.0	6 - 70	47	30	18.5	0.1	50	RRCMPG 2070

Material: Brass and Gunmetal

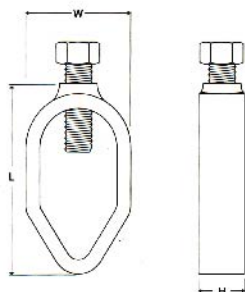

'U' Bolt Clamps

- Versatile range of 'U' bolt clamps
- Used to connect flat tape and stranded cables to earth rods, reinforcing bars (re-bar), hand rails, etc.

Single Plate Type for Horizontal Flat Tapes

Used to connect flat tapes in a horizontal position on the rod

Maximum Rod Dia. mm	Hole Centres mm	L mm	W mm	H mm	Unit Weight Kg.	Pack Quantity	Part Number
16	30	58	62	33	0.15	30	RRSPU 016
25	37	70	62	33	0.15	30	RRSPU 025
31	41	85	68	33	0.28	20	RRSPU 031
38	46	90	75	33	0.28	20	RRSPU 038
50	63	100	90	33	0.45	20	RRSPU 050

Material: Brass and Gunmetal



Double Plate Type for Vertical Flat Tapes

Used to connect flat tapes in a vertical position on the rod

Maximum Rod Dia. mm	Tape width mm	L mm	W mm	H mm	Unit Weight Kg.	Pack Quantity	Part Number
16		68	62	33	0.21	30	RRDPU 016
25		70	62	33	0.23	30	RRDPU 025
31	25	85	68	33	0.33	20	RRDOU 031
38		90	75	33	0.38	20	RRDPU 038
50		100	90	33	0.58	20	RRDPU 050

Material: Brass and Gunmetal

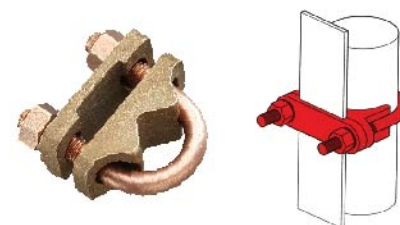

Double Plate Type for Vertical Stranded Cables

Used to connect stranded cables in vertical and horizontal positions on the rod

Maximum Rod Dia. mm	Conductor Range	L mm	W mm	H mm	Unit Weight Kg.	Pack Quantity	Part Number
	116 - 150	57	51	40	0.21	30	RRGUV 470
16	150 - 300	73	68	40	0.34	30	RRGUV 570
	16 - 17	57	51	40	0.21	30	RRGUV 470
20	70 - 300	73	68	40	0.34	30	RRGUV 570
	16 - 70	85	80	40	0.45	20	RRGUV 670
25	70 - 300	98	93	40	0.54	20	RRGUV 770

Material: Brass and Gunmetal

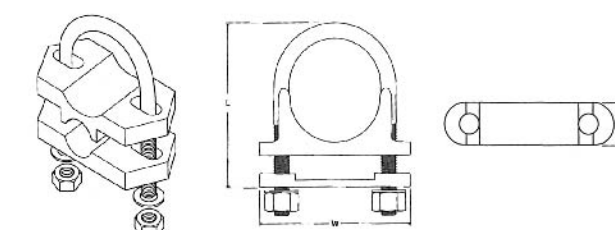
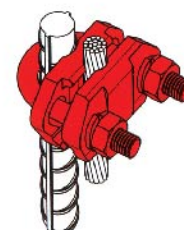
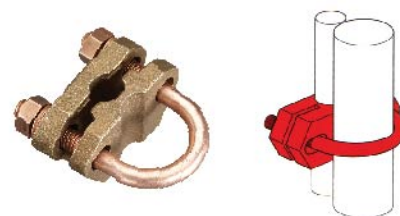

Re-bar Clamps



- Require bonding to concrete encased electrodes (Re-bar) in grounding systems
- Provide two connection points to the rebar
- Specifically designed to bond to reinforcing bars (Re-bars) RRRBR 70 and RRRBR 100
- Also bond with connections to steam pipes, handrails and similar metal structures
- Feature high-strength bronze alloy construction
- Provide a heavy-duty connection to Re-bar
- Meet standard requirements for bonding Re-bar into grounding system
- Install easily

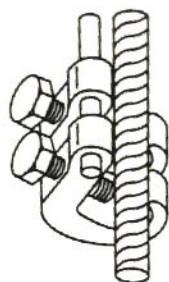

DIAMETER	REBAR DIAMETER	CONDUCTOR MATERIAL	PART NO.
8 MM	8 - 18 MM	GUNMETAL & COPPER	RRRBR 70
8 MM	18 - 38MM	GUNMETAL & COPPER	RRRBR 100

Split Connector Clamps



- Used to connect cable lugs onto earth rods
- Designed to suit our full range of earth rods
- Assembled with an M12 x 50mm set screw and fittings (RRRCL 95 assembled with M8 x 40mm set screw and fittings; RRRCL 142 assembled with wing nut)

Nominal Rod Size	Thread Size (UnC-2A)	L mm	W mm	H mm	Unit Weight Kg.	Pack Quantity	Part Number
5/8"	5/8"	42	26	26	0.22	25	RRRCL 5/8
3/4"	3/4"	50	29	29	0.31	25	RRRCL 3/4

Material: Gunmetal or Naval Brass

For use with Copperbond Earth Rods (on rod shank)

Rod Shank D mm	L mm	W mm	H mm	Unit Weight Kg.	Pack Quantity	Part Number
9.5	27	18	20	0.08	25	RRRCL 95
14.2	42	25	25	0.27	25	RRRCL 142

Material: Gunmetal or Naval Brass

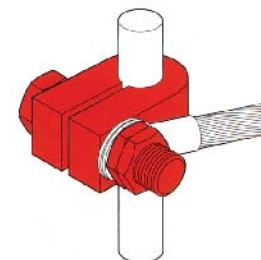

For use with Solid Copper & Stainless Steel Earth Rods (on rod shank)

Rod Shank D mm	L mm	W mm	H mm	Unit Weight Kg.	Pack Quantity	Part Number
15	42	26	25	0.22	25	RRRCLS 15
16	42	26	25	0.21	25	RRRCLS 16
20	50	29	29	0.28	25	RRRCLS 20

Material: Gunmetal or Naval Brass

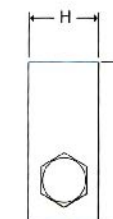
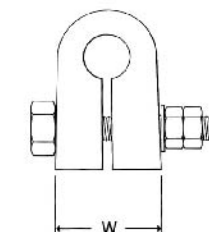



Solid Copper Earth Plates

- Provide long lasting earthing solutions, especially when driving earth rods may be impractical
- Often installed in conjunction with low-resistance Earthing Compound or Bentonite
- Can be made as per customer specifications

L x W mm	H mm	Unit Weight Kg.	Pack Quantity	Part Number
600 X 600	1.5	4.80	6	RRCEP 6015
600 X 600	3	9.61	3	RRCEP 603
600 X 600	5	16.02	2	RRCEP 605
500 X 500	3	6.67	5	RRCEP 503
500 X 500	5	11.12	3	RRCEP 505
900 X 900	3	21.62	1	RRCEP 903
900 X 900	5	36.04	1	RRCEP 905
1000 X 1000	3	26.70	1	RRCEP 1003
1000 X 1000	5	44.50	1	RRCEP 1005

Material: Copper to BS EN 12163 (formerly BS 2874)

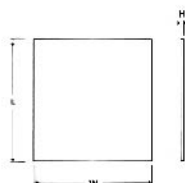
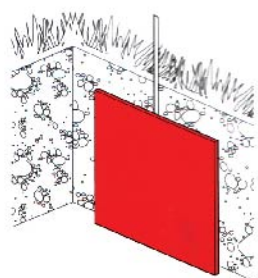

Solid Copper Lattice Mats

- More economical option to installing solid copper plates
- Often used for potential grading
- Preferred option in installations such as telecommunication towers, where touch and step potential could cause problems
- Can be made as per customer specifications

L x W mm	H mm	Grid	Unit Weight Kg.	Pack Quantity	Part Number
600 X 600	3	5	4	5	RRLCEP 603
900 X 900	3	6	7.2	2	RRLCEP 903
900 X 900	3	5	6.1	3	RRCLEP 9035

Material: Copper to BS EN 12163 (formerly BS 2874)

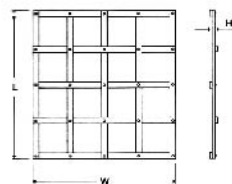
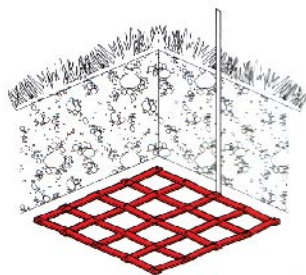

Inspection Housing Earth Bars (for Heavy Duty Earth Pits)

- Fit into slots provided in heavy duty earth inspection housings
- Used when multiple connections to the earth rod are required

No. Holes	Hole Dia mm	L mm	W mm	H mm	Unit Weight Kg.	Pack Quantity	Part Number
5	11	203	25	6	0.24	1	RREBH 35
7					0.22		RREBH 37

Material: Copper to BS EN 13601

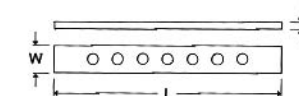
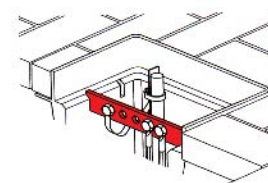

Inspection Housing Earth Bars (for Light Duty Earth Pits)

- Fit into slots provided in light duty earth inspection housings
- Used when multiple connections to the earth rod are required

No. Holes	Hole Dia mm	L mm	W mm	H mm	Unit Weight Kg.	Pack Quantity	Part Number
5	11	250	30	6	0.42	1	RREBL 25
7					0.39		RREBL 27

Material: Copper to BS EN 13601

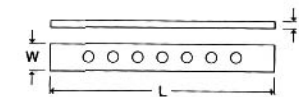
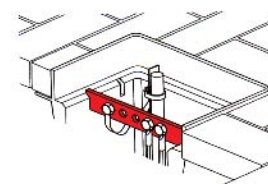

Inspection Housing Earth Bars (for Concrete Earth Pits)

- Fit into slots provided in concrete earth inspection housings
- Used when multiple connections to the earth rod are required

No. Holes	Hole Dia.	L mm	W mm	H mm	Unit Weight Kg.	Pack Quantity	Part Number
5	11	285	30	6	0.49	1	RREBC 05
7					0.5		RREBC 07

Material: Copper to BS EN 13601

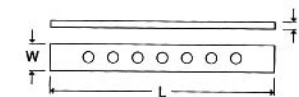
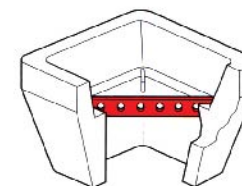



Concrete Earth Pit

- These pits provide access to earth rods and the corresponding connections to earthing grids
- Isolate the connections made at the top of earth rods from the surrounding soil, protecting these connections and providing access for testing and maintenance
- To protect the earth pits against ingress of foreign material, an appropriate concrete cover is provided to be placed atop the earth pit
- The pit is load related to 4000 kilograms
- Can be fitted with diagonal earth bar in the slots provided at the base
- Suitable for most industrial applications

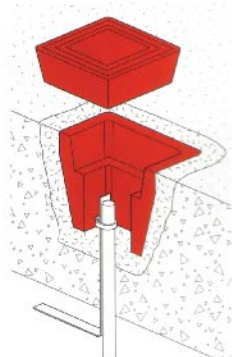

L mm	W mm	H mm	Unit Weight Kg.	Pack Quantity	Part Number
310	310	170	23.0Appx.	1	RREPT 310

Material: Concrete

*Weight and dimension variance: 5%

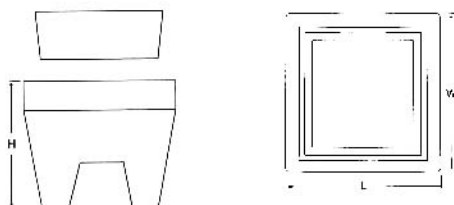

Earth Bars

- Available in a variety of sizes and specifications (Standard earth bars are shown in the tables below)
- Customization to customer's requirements is also possible
- Fixing by countersunk wood screw 1½" x No. 12 and No. 12 wall plug is recommended
- Base plate made from steel; also available in plastic

Earth Bars

No. Terminations	L mm	W mm	H mm	Unit Weight Kg.	Pack Quantity	Part Number
6	400	90	60	2.00	1	RROCL 006
8	500			2.30		RROCL 008
10	650			3.20		RROCL 010
12	750			4.00		RROCL 012
14	850			4.90		RROCL 014
16	950			5.80		RROCL 016
18	1100			6.70		RROCL 018
20	1250			7.60		RROCL 020
22	1300			8.50		RROCL 022
24	1400			9.40		RROCL 024
26	1550			10.30		RROCL 026
28	1650			11.20		RROCL 028
30	1800	12.10	RROCL 030			

Earth Bars with Single Disconnecting Link

No. Terminations	L mm	W mm	H mm	Unit Weight Kg.	Pack Quantity	Part Number
6	485	90	60	2.50	1	RRSDCL 106
8	585			3.00		RRSDCL 108
10	735			3.90		RRSDCL 110
12	835			4.70		RRSDCL 112
14	935			5.60		RRSDCL 114
16	1035			6.50		RRSDCL 116
18	1185			7.40		RRSDCL 118
20	1335			8.30		RRSDCL 120
22	1385			9.20		RRSDCL 122
24	1485			10.10		RRSDCL 124
26	1635			11.00		RRSDCL 126
28	1735			11.90		RRSDCL 128
30	1885	12.80	RRSDCL 130			

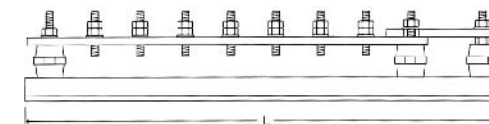
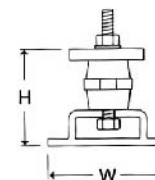

Earth Bonding Points

- Connect the re-bar to the earthing or lightning protection system
- Provide convenient earth system connection point in concrete structures



No. Holes	Hole Size mm	Plate Size mm	Stem Dia mm	L mm	Unit Weight kg.	Pack Quantity	Part Number
1		38 x 38			0.16		RREBP 01
2	M10 x 20	70 x 35	10.7	75	0.28	10	RREBP 02
3		65 X 65	[70mm²]		0.54		RREBP 04

Material: Gunmetal

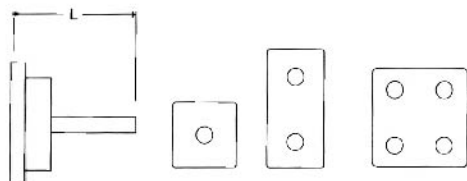

Earth Bars

Earth Bars with Double Disconnecting Links

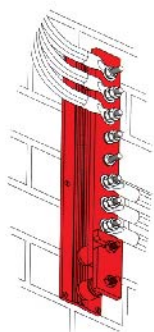

No. Terminations	L mm	W mm	H mm	Unit Weight Kg.	Pack Quantity	Part Number
6	570	90	60	3.10	1	RRDDCL 206
8	670			RRDDCL 208		
10	820			RRDDCL 210		
12	920			RRDDCL 212		
14	1020			RRDDCL 214		
16	1120			RRDDCL 216		
18	1270			RRDDCL 218		
20	1420			RRDDCL 220		
22	1470			RRDDCL 222		
24	1570			RRDDCL 224		
26	1720			RRDDCL 226		
28	1820			RRDDCL 228		
30	1885			RRDDCL 230		

Material:

Bar: 50x6mm hard drawn copper bar to BS EN 13601

Base: Steel / Plastic

Fittings: M10 Hexagon Head Set Screws, Nuts & Washers.

Insulators

• Supplied with or without studs and locking nuts



Type	Thread size	W mm	H mm	Unit Weight Kg.	Pack Quantity	Part Number
Insulator Only	M10	40	40	0.08	10	RRINS 001
Insulator with 2 studs & 3 nuts				0.16		RRINS 002

Material: DMC

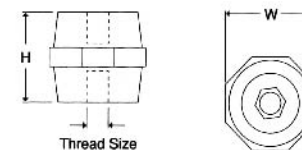

Earth Blocks / Neutra Link

• Allow earth conductor termination or live conductor termination with a suitable, fully insulated housing

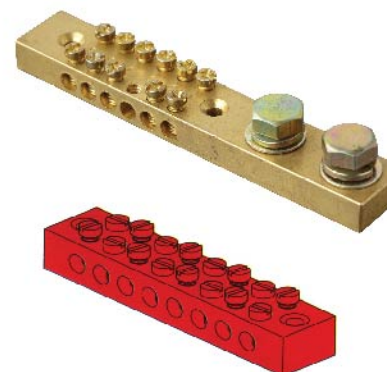

Type	L mm	W mm	H mm	Unit Weight Kg.	Pack Quantity	Part Number
4-Way Single	54	9	12	0.06	100	RREB 004/1
4-Way Double	51	18	12	0.09	100	RREB 004
8-Way Single	88	18	12	0.15	100	RREB 008

Material: Tinned Brass

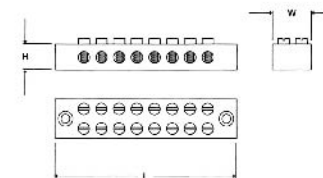

Disconnecting Link

• Provides temporary break in the earth connection to allow inspection and testing of the earth electrodes

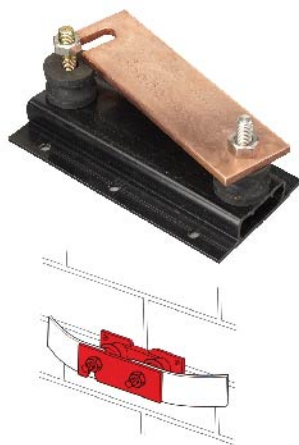

L mm	W mm	H mm	Unit Weight Kg.	Pack Quantity	Part Number
120	45	45	0.6	1	RRDL 100

Material:

Bar: 50x6mm hard drawn copper bar to BS EN 13601

Base: Steel / Plastic

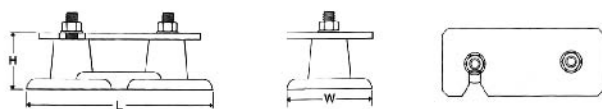

Earth Boss

• Welded onto steel vessels, tanks and other structures
• Designed to provide an earth connection point on a steel structure

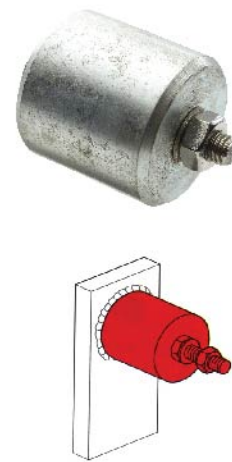

D mm	L mm	Thread Size	Unit Weight Kg.	Pack Quantity	Part Number
50	50	M10	0.77	5	RREBS 5050
50	40	M10	0.62	5	RREBS 5040
50	30	M10	0.47	5	RREBS 5030
40	40	M10	0.47	5	RREBS 4040
40	30	M10	0.35	5	RREBS 4030

Material: Mild Steel with Stainless Steel fittings.

Also available in Stainless steel

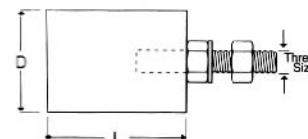

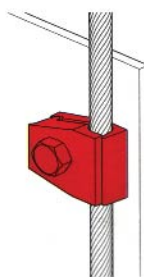

Tower Earth Clamps

- Used for bonding copper conductors onto steel surfaces
- Double-plate design provides robust fixing in areas where cladding may be installed or where the complete clamp will be covered by concrete
- Fixed by drilling a hole in the steelwork and securing with the set screw provided

Conductor Range mm ²	L mm	W mm	H mm	Set Screw	Unit Weight kg	Pack Quantity	Part Number
16 - 70	45	30	17	M10x50mm	0.12	20	RRTEC 070
70 - 120	48	35	22	M12x60mm	0.22	20	RRTEC 120
120 - 185	55	40	28	M12x75mm	0.29	20	RRTEC 185
185 - 240	63	45	35	M12x80mm	0.39	20	RRTEC 240
240 - 300	70	53	42	M12x90mm	0.59	20	RRTEC 300

Material: Brass and Gunmetal

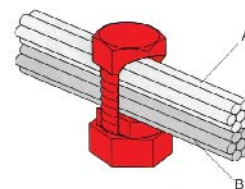
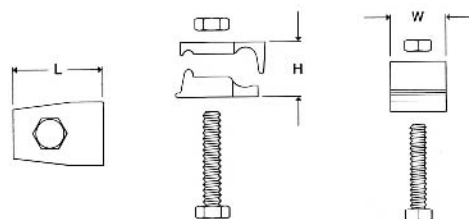

Split Bolt Connectors

- High strength split bolt connectors accept a wide range of stranded copper conductors
- No specialist tools required for installation

Main Conductor A mm ²	Unit Weight Kg.	Pack Quantity	Part Number
10	0.029	50	RRSBC 10
16	0.029	50	RRSBC 16
25	0.035	50	RRSBC 25
32 - 35	0.063	50	RRSBC 35
50	0.12	50	RRSBC 50
70	0.14	50	RRSBC 70
95	0.165	25	RRSBC 95
120	0.235	25	RRSBC 120
150	0.235	25	RRSBC 150
185	0.275	25	RRSBC 185
240	0.52	25	RRSBC 240
300	0.603	25	RRSBC 300
400	0.81	25	RRSBC 400
500	1.21	25	RRSBC 500

Material: Brass with and without copper and tin plating

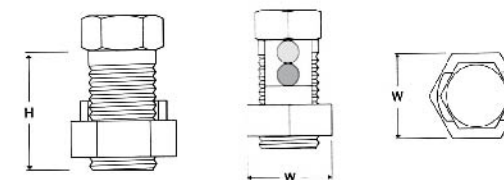

Parallel Groove Clamps

- Manufactured from high-strength, corrosion-resistant copper alloy
- Assembled with two stainless steel set screws
- Used for stranded copper cable connection

Conductor Range mm ²	L mm	W mm	H mm	Set Screw	Unit Weight kg	Pack Quantity	Part Number
25 - 70	50	40	7	M8x35mm	0.38	20	RRPGC 070
70 - 95	54	45	8.5	M10x45mm	0.46	20	RRPGC 095
95 - 185	65	57	12.5	M10x55mm	0.54	20	RRPGC 185
185 - 240	78	71	14	M10x55mm	0.65	20	RRPGC 240
240 - 300	94	85	16	M10x60mm	0.37	20	RRPGC 300

Material: Brass and Gunmetal

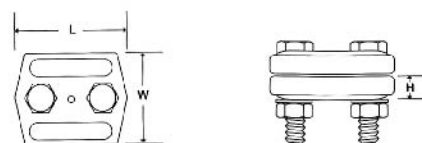



Flexible Copper Braid Bonds

- Used for bonding metal gates, doors, fences, etc.
- Customized lengths and sizes available on request
- Made using terminal lugs

Size W x H mm	Hole Centres L mm	Hole Size mm	Unit Weight Kg.	Pack Quantity	Part Number
25 X 3.5	200	11	0.09	10	RRFCBB 200
	300		0.13		RRFCBB 300
	400		0.16		RRFCBB 400

Material: Copper

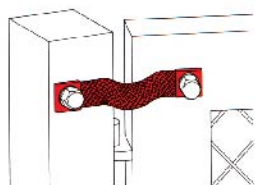

Ready Made Tinned Copper Braid

Sq.mm	Hole	Length	Max Current	Kg / Pc	Part Number
6	7	100	55A	0.02	RRRCB 6 -100
6	7	150	55A	0.03	RRRCB 6 -150
10	9	100	85A	0.025	RRRCB 10 -100
10	9	150	85A	0.035	RRRCB 10 -150
10	9	200	85A	0.045	RRRCB 10 -200
10	9	250	85A	0.055	RRRCB 10 -250

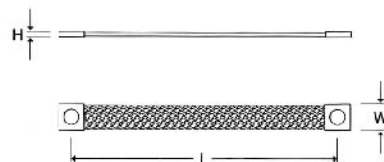

Static Earth Receptacle

- Used in open areas where a temporary earthing point may be required, such as airfields or petrol stations
- Provides static discharge point for aircraft, tankers, vehicles and boats

H mm	D mm	Unit Weight Kg.	Pack Quantity	Part Number
135	125	6.5	2	RRERX 05

Material: Brass and Gunmetal

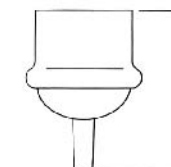
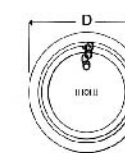
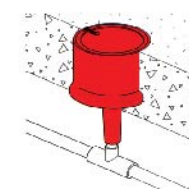

Eyebolts

- Provides static earth point when attached to the top of a threaded copperbond earth rod

Thread Size (UNC-2A)	H mm	Unit Weight Kg.	Pack Quantity	Part Number
5/8"	135	0.62	5	RREYE 058
3/4"		0.55	5	RREYE 034

Material: Brass

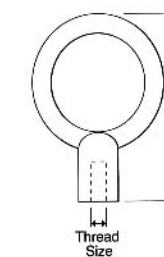



WE MAKE YOU FEEL SAFE!

A proper structural Lightning Protection System is installed to reduce the risk of injury to life and property in the event of a lightning strike. It minimizes the risk of damage to the external and internal parts of structures by safely discharging the high voltage to the Earthing System.

1. INTRODUCTION _____ 36

2. FLAT TAPE SYSTEM _____ 38

3. SOLID CIRCULAR SYSTEM _____ 50

4. CABLE AND WIRE SYSTEM _____ 54

Lightning Protection System Design Considerations

The entire system is to be designed taking into consideration geographical location, soil conditions, structural design, material used in making the structure, activity carried out in the structure and local terrain.

Down Conductors

Use of down conductors is specifically based on the design of the System. A Flat Conductor or a Round Conductor may be used as a Down Conductor. The dimensions of the conductor are crucial to the System and are based on the risk assessment.

Earth Terminations

An earth electrode should be connected to each down conductor which constitutes the Lightning Protection System. An Earth Inspection Pit is required for earth rods to enable periodic inspection, testing and maintenance of earth resistance.

Resistance to earth

For a Lightning Protection System, the maximum resistance value for the earth termination network is specific to area and application. In case a single earth rod is not sufficient to achieve the required resistance, several earth rods may be used. In such case, the combined resistance of the rods is proportional to reciprocal of individual rod resistance. Normally, the minimum spacing between the rods should not be less than their driven length. In geographical locations which make it impossible to use rods of longer length, rods with larger diameter or copper earth mats and earth plates can be used.

A lower resistance value can be obtained by maximising the utilization of the rods, increasing the length of the rods to drive them deeper or by using rods of a larger diameter.



Joints

A complex Lightning Protection System would involve joints and crossovers for which mechanical clamps are used. Each such clamp is a potential source of discontinuity. Hence, it should be ensured that the contact surfaces are clean and that the clamps are tightly fixed and well protected from corrosion, which could also occur if two dissimilar metals are joined. Ideally, a Lightning Protection System design should comprise of as few as joints as possible.

Life and maintenance of an Lightning Protection System

It is important to properly maintain a Lightning Protection System to ensure it retains its ability to conduct the same current carrying capacity as it did when it was installed. Earth rod resistances should be regularly checked. Corrosion and fault currents can cause high resistance joints, which can lead to overheating. However, a properly installed and maintained system can last for several years.



Taper Pointed Air Rods

- Important part of the air termination network for Lightning Protection System
- Supplied with locknut enabling the rod to be locked tight against the conductor
- Also available in customised diameter as per customer specifications

Copper Air Rods

Thread Size	L mm	L1 mm	Unit Weight Kg.	Pack Quantity	Part Number
M16	300	41	0.53	10	RRTPAR 1430
M16	500	41	0.85	10	RRTPAR 1450
M16	1000	41	1.70	10	RRTPAR 1410
M16	1500	41	2.59	10	RRTPAR 1415
M16	2000	41	3.47	10	RRTPAR 1420
M20	300	41	0.80	7	RRTPAR 1730
M20	500	41	1.34	7	RRTPAR 1750
M20	1000	41	2.68	7	RRTPAR 1710
M20	1500	41	4.02	7	RRTPAR 1715
M20	2000	41	5.36	7	RRTPAR 1720

Material: Brass and Copper

Aluminium Air Rods

Thread Size	L mm	L1 mm	Unit Weight Kg.	Pack Quantity	Part Number
M16	300	41	0.18	10	RRTPAR 1430 A
M16	500	41	0.29	10	RRTPAR 1450 A
M16	1000	41	0.57	10	RRTPAR 1410 A
M16	1500	41	0.98	10	RRTPAR 1415 A
M16	2000	41	1.09	10	RRTPAR 1420 A

Material: Aluminium

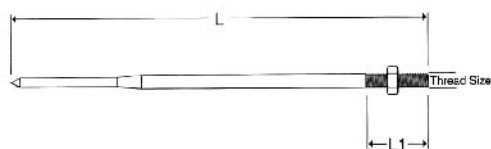
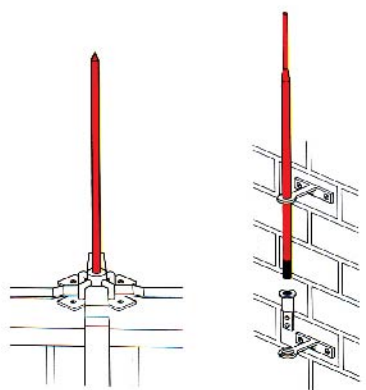
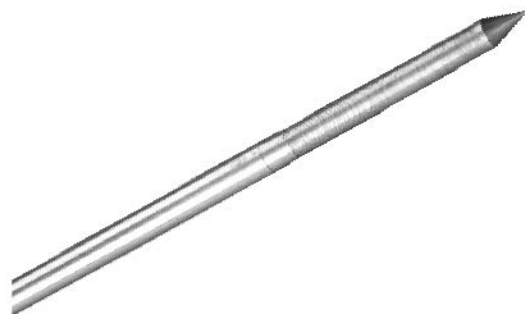

Multi-Point

Used in conjunction with taper pointed copper air rods

Air Rod Dia. mm	H mm	W mm	Unit Weight Kg.	Pack Quantity	Part Number
16 & 20	156	72	0.3	5	RRMUP

Material: Brass and Copper

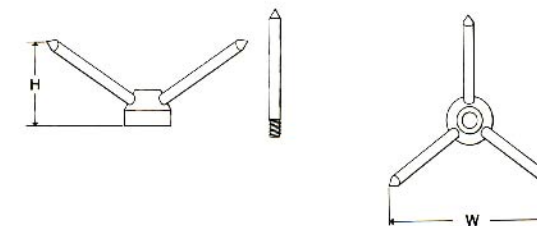

Flat Air Rod Saddles

Used to support air rods on flat roof surfaces

For use with Aluminium Air Rods

Thread Size	L mm	H mm	Unit Weight Kg.	Pack Quantity	Part Number
M16	137	40	0.6	10	RRFARS 16M

Material: Brass and Gunmetal

For use with Aluminium Air Rods

Thread Size	L mm	H mm	Unit Weight Kg.	Pack Quantity	Part Number
M16	137	40	0.2	10	RRFARS 16A

Material: Aluminium

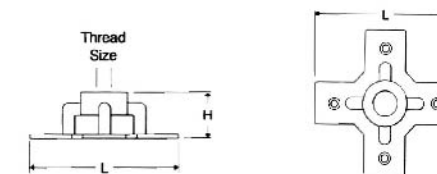
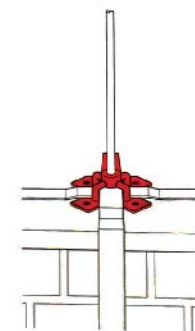



Air Rod Ridge Saddles

Used to support air rods on roof ridges

For use with Copper Air Rods

Thread Size	L mm	H mm	Unit Weight Kg.	Pack Quantity	Part Number
M16	137	34	0.7	10	RRRS 16
M20	137	34	0.7	10	RRRS 20

Material: Brass and Gunmetal

For use with Aluminium Air Rods

Thread Size	L mm	H mm	Unit Weight Kg.	Pack Quantity	Part Number
M16	137	34	0.25	10	RRRS 16 A

Material: Aluminium

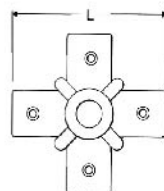
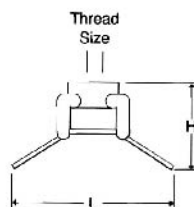
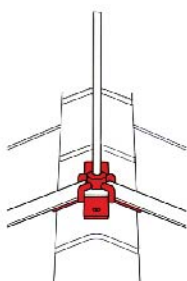

Side Mounting Air Rod Brackets

- Used where it is not possible to fit a saddle onto the building roof
- Used in conjunction with rod to tape coupling used to secure the flat tape to the air rod
- Provide 75mm projection from the building face

For use with Aluminium Air Rods

Rod Dia mm	L mm	H mm	Unit Weight Kg.	Pack Quantity	Part Number
16	97	120	0.39	10	RRARB 16
20	97	120	0.43	10	RRARB 20

Material: Brass and Gunmetal

For use with Aluminium Air Rods

Rod Dia mm	L mm	H mm	Unit Weight Kg.	Pack Quantity	Part Number
16	97	120	0.120	10	RRARB 16A

Material: Aluminium

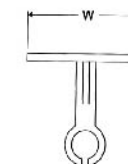
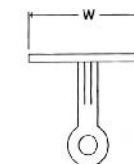

Light Duty Air Rod Saddles

Used to support air rods on flat roof surfaces

For Use with Copper Air Rods

Thread Size	L mm	H mm	Unit Weight Kg.	Pack Quantity	Part Number
M10	101	37	0.360	10	RRLDS 10
M16	101	37	0.360	10	RRLDS 16
M20	101	37	0.360	10	RRLDS 20

Material: Gunmetal

For use with Aluminium Rods

Thread Size	L mm	D mm	Unit Weight Kg.	Pack Quantity	Part Number
M16	137	40	0.200	10	RRRTC 16 A

Material: Aluminium

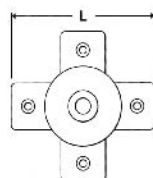
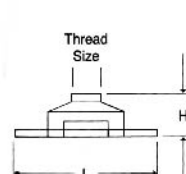
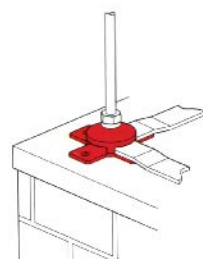

Rod to Tape Couplings

- Used to connect flat tape to air rod
- Used in conjunction with side mounting air rod brackets

For use with Aluminium Air Rods

Thread Size	L mm	H mm	Unit Weight Kg.	Pack Quantity	Part Number
16	80	40	0.22	10	RRRTC 16
20	80	40	0.22	10	RRRTC 20

Material: Gunmetal

For use with Aluminium Air Rods

Thread Size	L mm	H mm	Unit Weight Kg.	Pack Quantity	Part Number
M16	80	40	0.10	10	RRRTC 16 A

Material: Aluminium

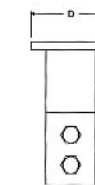
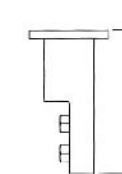
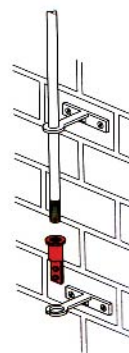

Metallic DC Clips

- Secure flat tape conductor to building surface
- Fixed using countersunk woodscrew 1½" No. 10 and No. 10 wall plug

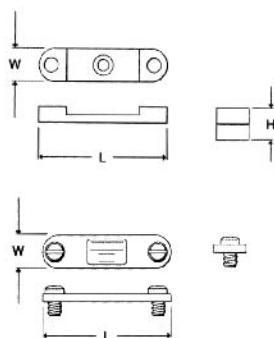
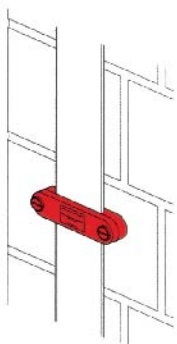

For use with Bare Copper Tapes

Conductor Size mm	L mm	W mm	H mm	Unit Weight Kg.	Pack Quantity	Part Number
20 x 3	50	20	10	0.06	50	RRDCTC 203
25 x 3	50	20	10	0.06	50	RRDCTC 253
25 x 4	50	20	10	0.06	50	RRDCTC 254
25 x 6	50	20	12	0.06	50	RRDCTC 256
30 x 5	56	20	11	0.08	30	RRDCTC 305
31 x 3	60	20	10	0.08	30	RRDCTC 313
31 x 6	60	20	13	0.09	30	RRDCTC 316
38 x 3	64	20	10	0.08	30	RRDCTC 383
38 x 5	64	20	13	0.10	30	RRDCTC 385
38 x 6	64	20	13	0.10	30	RRDCTC 386
40 x 4	70	20	12	0.10	30	RRDCTC 404
40 x 5	70	20	14	0.10	30	RRDCTC 405
40 x 6	70	20	14	0.10	30	RRDCTC 406
50 x 3	80	20	10	0.10	30	RRDCTC 503
50 x 4	80	20	11	0.10	30	RRDCTC 504
50 x 6	80	20	14	0.140	30	RRDCTC 506
50 x 8	80	20	14	0.140	30	RRDCTC 508

Material: Brass and Gunmetal

For use with PVC Covered Copper Tapes

Conductor Size mm	L mm	W mm	H mm	Unit Weight Kg.	Pack Quantity	Part Number
25 x 3	55	20	14	0.06	30	RRDCTCP 253
25 x 6	58	20	18	0.11	30	RRDCTCP 256
50 x 6	91	20	19	0.2	30	RRDCTCP 506

Material: Brass and Gunmetal

For use with Bare Aluminium Tapes

Conductor Size mm	L mm	W mm	H mm	Unit Weight Kg.	Pack Quantity	Part Number
25 x 3	55	20	10	0.02	30	RRDCTC 253 A
25 x 6	50	20	13	0.03	30	RRDCTC 256 A
50 x 6	80	20	16	0.04	30	RRDCTC 506 A
60 x 6	90	20	17	0.05	30	RRDCTC 606 A

Material: Aluminium

Tape Clips

- Holds flat tape conductor to the building surface
- Fixed using countersunk woodscrews 1½" No. 10 and No. 10 wall plugs

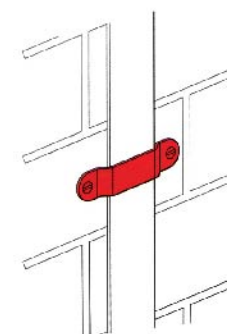

For use with Copper Tapes

Conductor Size mm	L mm	W mm	H mm	Unit Weight Kg.	Pack Quantity	Part Number
20 x 3	68	20	7	0.03	100	RRCTC 203
25 x 3	70	20	7	0.03	100	RRCTC 253
50 x 6	73	20	8	0.05	100	RRCTC 506

Material: Copper

For use with PVC covered Copper Tapes

Conductor Size mm	L mm	W mm	H mm	Unit Weight Kg.	Pack Quantity	Part Number
25 x 3	70	20	7	0.03	100	RRCTC 253 P

Material: Copper

For use with Bare Aluminium Tapes

Conductor Size mm	L mm	W mm	H mm	Unit Weight Kg.	Pack Quantity	Part Number
20 x 3	68	20	7	0.01	100	RRCTC 203 A
25 x 3	70	20	7	0.01	100	RRCTC 253 A

Material: Aluminium

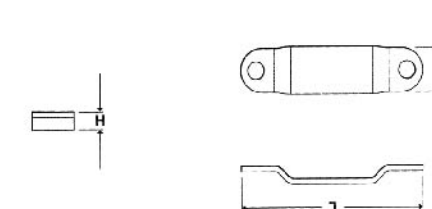



Glazing Bar Holdfasts

- Originally designed to be used on glazing units
- Can be installed wherever conductor has to be fixed onto a narrow flange
- Assembled with a fixing screw for use with a metallic or non-metallic DC clip

For use with Copper Tapes

L mm	W mm	H mm	Unit Weight Kg.	Pack Quantity	Part Number
35	22	20	0.12	20	RRGBH 12

Material: Brass and Gunmetal

For use with Aluminium Tapes

Conductor size mm	L mm	W mm	Unit Weight Kg.	Pack Quantity	Part Number
35	22	20	0.04	20	RRGBH 12 A

Material: Aluminium

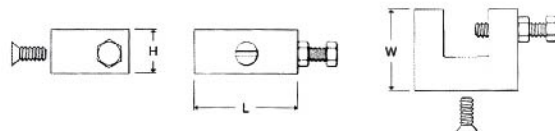

Square Tape Clamps

- Four-way connectors, suitable for making cross, straight through or tee joints in flat tape
- Countersunk hole in the middle of the base for securing clamp to the building surface (Lid fixed by using four screws)
- Fixed using countersunk woodscrew 1½x No. 10 and No. 10 wall plug

For use with Bare Copper Tapes

Conductor Size mm	L mm	W mm	H mm	Unit Weight Kg.	Pack Quantity	Part Number
25 x 3	50	50	13	0.15	50	RRSTC 253
25 x 6	50	50	20	0.25	50	RRSTC 256
31 x 3	60	60	14	0.22	50	RRSTC 313
38 x 6	71	71	22	0.59	50	RRSTC 386
50 x 3	80	80	16	0.50	20	RRSTC 503
50 x 6	79	79	22	0.52	20	RRSTC 506

Material: Brass and Gunmetal

For use with Aluminium Tapes

Conductor Size mm	L mm	W mm	H mm	Unit Weight Kg.	Pack Quantity	Part Number
25 X 3	50	50	13	0.07	50	RRSTC 253 A

Material: Aluminium

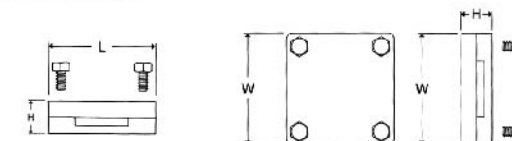
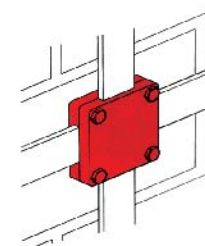

Black Plate Holdfasts

- Designed to be used where necessary to hold conductor away from the building surface
- Assembled with a fixing screw for use with a metallic or non-metallic DC clip

For use with Copper Tapes

L mm	W mm	Unit Weight Kg.	Pack Quantity	Part Number
74	63	0.33	5	RRBPH 1

Material: Gunmetal

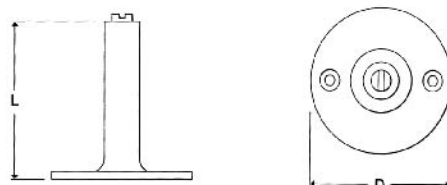
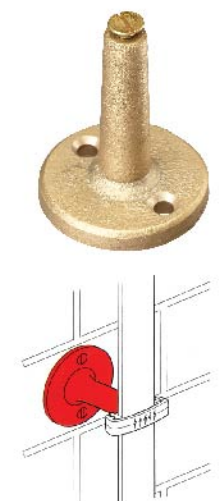



Oblong Junction Clamps

- Designed to join a range of tape sizes in a straight through position
- Also enables tapes to be overlapped and secured by two set screws

For use with Bare Copper Tapes

Maximum Conductor Size mm	L mm	W mm	H mm	Unit Weight Kg.	Pack Quantity	Part Number
26 x 8	68	40	23	0.34	20	RROJC 253
51 X 10	90	63	26	0.58	20	RR OJC 506

Material: Brass and Gunmetal

For use with Bare Aluminium Tape

Maximum Conductor Size mm	L mm	W mm	H mm	Unit Weight Kg.	Pack Quantity	Part Number
26 x 8	68	40	23	0.34	20	RROJC 253 A

Material: Aluminium

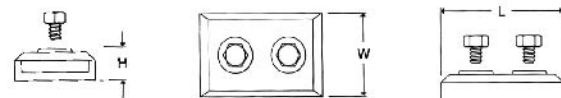
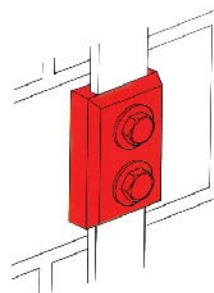

Screw Down Test Clamp

- Allows easy access to copper conductors where frequent inspection and testing may be necessary

For use with Copper Tapes

Maximum Conductor Size mm	L mm	Unit Weight Kg.	Pack Quantity	Part Number
26 X 8	61	0.72	5	RRSDTC 253

Material: Gunmetal

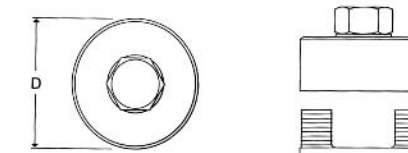
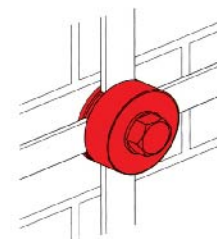

Plate Type Test Clamps

- Used to form a disconnecting joint between the down conductor and earthing system
- Equipped with two wall fixing holes on the bottom plate
- Fixed using countersunk woodscrews 1½" No. 10 and No. 10 wall plugs

For use with Copper Tapes

Maximum Conductor Size mm	L mm	W mm	H mm	Unit Weight Kg.	Pack Quantity	Part Number
26 x 15	70	40	38	0.40	20	RRPTTC 2615

Material: Brass and Gunmetal

For use with Aluminium Tapes

Maximum Conductor Size mm	L mm	H mm	Unit Weight Kg.	Pack Quantity	Part Number
26 X 15	70	38	0.1	20	RRPTTC 2615 A

Material: Aluminium

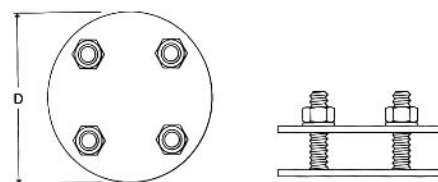
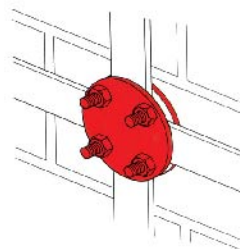

Bimetallic Connectors

- Made by friction welding process
- Used to join aluminium and copper tapes together
- Neat and practical jointing method
- Eliminate need for tinning, riveting or wrapping joint
- Fixed using saddle

Conductor Size mm	Material Type	L mm	W mm	H mm	Unit Weight Kg.	Pack Quantity	Part Number
25 x 3	Aluminium & Copper	98	29	25	0.2	25	RRBMC253

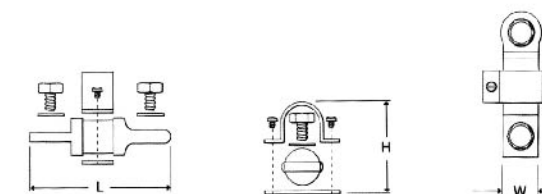
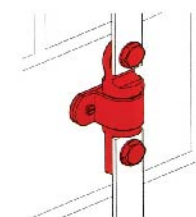



'B' Bonds

- Used for bonding aluminium and copper tapes to flat metal surfaces

For use with Copper Tapes

Conductor Size mm	L mm	W mm	H mm	Unit Weight Kg.	Pack Quantity	Part Number
25 x 3	35	35	10	0.03	50	RRBB 253

Material: Brass and Gunmetal

For use with Aluminium Tapes

Conductor Size mm	L mm	W mm	H mm	Unit Weight Kg.	Pack Quantity	Part Number
25 x 3	35	35	10	0.01	50	RRBB 253 A

Material: Aluminium with M10 x 35mm Stainless Steel Set Screw

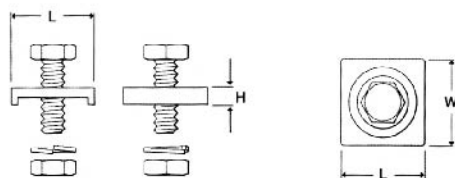
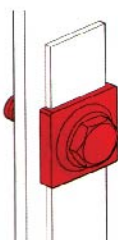

Rainwater Pipe Bond

- Can be used on any application where tape needs to be wrapped around circular objects such as pipes or rails

For use with Bare Copper Tapes

Maximum Conductor Width mm	L mm	W mm	Height	Unit Weight Kg.	Pack Quantity	Part Number
26	35	35	16	0.21	50	RRPB 253

Material: Brass and Gunmetal

For use with Bare Aluminium Tapes

Maximum Conductor Width mm	L mm	W mm	Height	Unit Weight Kg.	Pack Quantity	Part Number
26	32	32	16	0.2	50	RRPB 253 A

Material: Aluminium

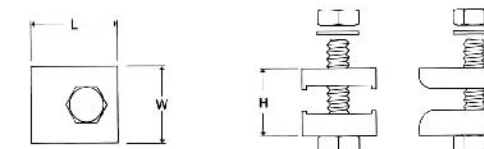
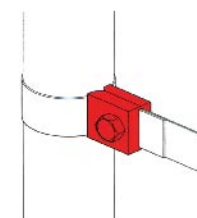

Watermain Pipe Bond

- Designed to bond large diameter metallic pipes into earthing and lightning protection systems

For use with Bare Copper Tapes

Maximum Conductor Width mm	L mm	W mm	Unit Weight Kg.	Pack Quantity	Part Number
26	46	35	0.21	50	RRBB 253

Material: Brass and Gunmetal

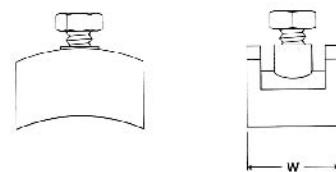
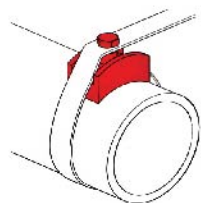

Air Rods

- Manufactured from 10mm and 12mm diameter rods
- Supplied with lock nut
- Used as part of Lightning Protection Systems
- Also can be made as per customer specifications
- Made from electrolytic grade copper

Copper Air Rods

Thread Size	Length mm	Unit Weight kg.	Pack Quantity	Part Number
M10	500	0.35	10	RRARS 105
M10	1000	0.7	10	RRARS 1010
M12	500	0.5	10	RRARS 125
M12	1000	1	10	RRARS 1210

Material: Copper

Aluminium Air Rods

Thread Size	Length mm	Unit Weight kg.	Pack Quantity	Part Number
M10	500	0.11	10	RRARS 105 A
M10	1000	0.22	10	RRARS 1010 A

Material: Aluminium

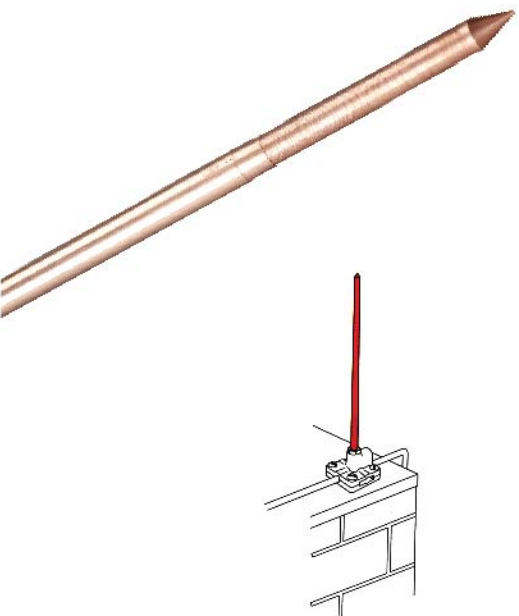
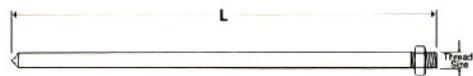

One Hole Conductor Clips

- Provide easy method of fixing copper and aluminium conductors to surfaces
- Fixed using round head woodscrew 1 1/2" No.10 and No. 10 wall plug

For use with Solid Circular Copper Conductors

Conductor Size & Type	L mm	W mm	H mm	Unit Weight kg	Pack Quantity	Part Number
8 mm Bare	31	12	12	0.01	200	RROHCC 1
8 mm PVC	41	20	15	0.01	200	RROHCC 1P

Material: Copper

For use with Solid Circular Aluminium Conductors

Conductor Size & Type	L mm	W mm	H mm	Unit Weight kg	Pack Quantity	Part Number
8 mm Bare	31	12	12	0.01	200	RROHCC 1A
8 mm PVC	41	20	15	0.01	200	RROHCC 1PA

Material: Aluminium

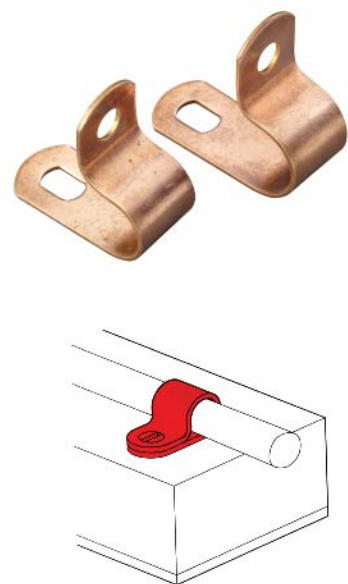
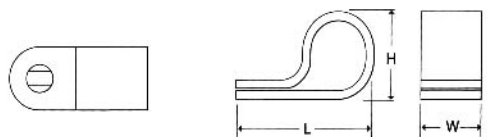

Metallic Conductor Clips (Saddle)

- Secure solid circular conductor to the building surfaces
- Larger sizes can also be used to support 10mm air rods
- Fixed using round head woodscrew 1 1/2" No.10 and No. 10 wall plug
- Can be made as per customers specifications

For use with Solid Circular Copper Conductors

Conductor Size & Type	L mm	W mm	H mm	Unit Weight kg.	Pack Quantity	Part Number
8 mm Bare	48	17	20	0.06	200	RRMCC 810
8 mm PVC	48	17	20	0.06	200	RRMCC 810P

Material: Copper

For use with Solid Circular Aluminium Conductors

Conductor Size & Type	L mm	W mm	H mm	Unit Weight kg.	Pack Quantity	Part Number
8 mm Bare	48	17	20	0.06	200	RRMCC 810A
8 mm PVC	48	17	20	0.06	200	RRMCC 810PA

Material: Aluminium

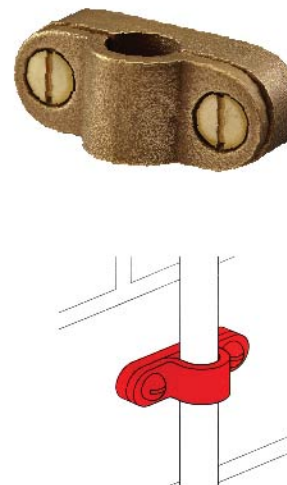
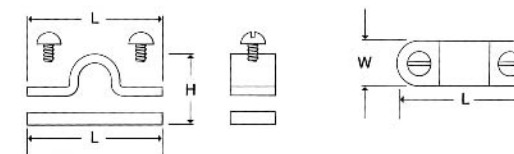

'T' Connector Clamps

- Designed for connecting roof network to down conductors of 8mm solid circular Lightning Protection Systems

For use with Bare Solid Circular Copper Conductor

Conductor Size mm	L mm	W mm	H mm	Unit Weight kg.	Pack Quantity	Part Number
8	45	45	19	0.11	50	RRTCC 8

Material: Brass and Gunmetal

For use with Bare Solid Circular Aluminium Conductor

Conductor Size mm	L mm	W mm	H mm	Unit Weight kg.	Pack Quantity	Part Number
8	44	25	20	0.06	50	RRTCC 8A

Material: Aluminums

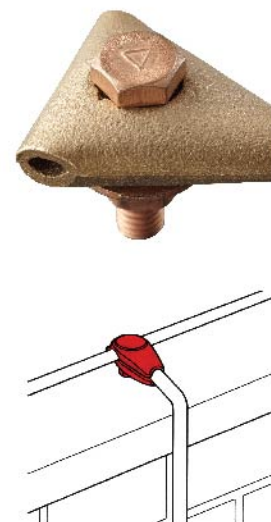
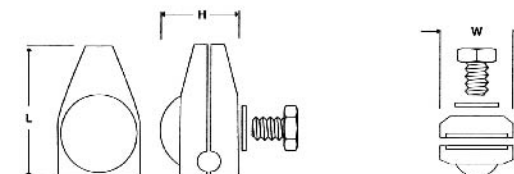



Interface Test Clamps

- Used for connecting flat tape to solid circular conductor, where Lightning Protection System is designed in 8mm Copper Conductor but connection to earth rod is made using 25mm x 3mm flat copper tape
- Can also be used to make through joints and tee connections in 8mm solid circular conductors

For use with Bare Copper Conductors

Conductor Size mm	L mm	W mm	H mm	Unit Weight kg.	Pack Quantity	Part Number
25 x 3 & 8	70	34	15	0.25	50	RRITC 2538

Material: Brass and Gunmetal

For use with Bare Aluminum Conductors

Conductor Size mm	L mm	W mm	H mm	Unit Weight kg.	Pack Quantity	Part Number
25 x 3 & 8	70	34	15	0.09	50	RRITC 2538 A

Material: Aluminium

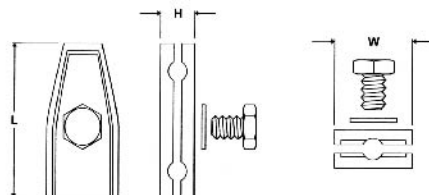
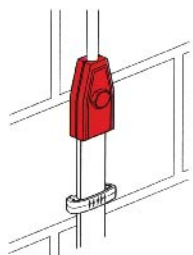

Bimetallic Connectors

- Used to join 8mm aluminium and copper solid circular conductors together
- Practical when Lightning Protection System has been designed with copper and aluminium conductors
- Eliminate need for tinning, riveting or wrapping joint
- Made by friction welding process

Conductor Size mm	Type	L mm	W mm	H mm	Unit Weight kg.	Pack Quantity	Part Number
8	Aluminums & Copper	78	28	28	0.25	25	RRBIM 8
8	Stainless Steel	71	22	19	0.09	25	RRBSS 8

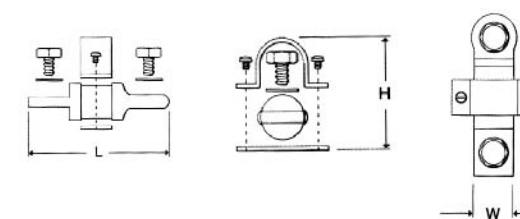
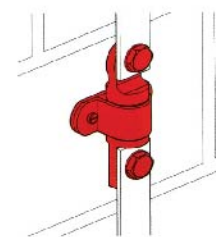

Tower Earth Clamps

- Used for bonding copper and aluminium conductors on to steel surfaces
- Fixed by drilling hole in the steelwork and securing with the set screw provided

For use with Bare Solid Circular Copper Conductor

Conductor Size mm	L mm	W mm	H mm	Set Screw	Unit Weight kg.	Pack Quantity	Part Number
8	34	23	33	M10 x 50mm	0.09	25	RRTEC 8

Material: Brass and Gunmetal

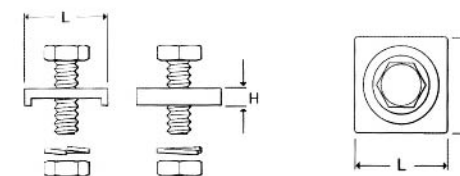
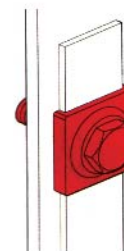

Taper Pointed Air Rods

- Important part of air termination network of Lightning Protection System
- Supplied with locknut, enabling rod to be locked tight against the conductor
- Can be made as per customer specifications
- Made from electrolytic grade copper

Thread Size	L mm	L1 mm	Unit Weight Kg.	Pack Quantity	Part Number
M16	300	41	0.53	10	RRTPAR 1430
M16	500	41	0.85	10	RRTPAR 1450
M16	1000	41	1.7	10	RRTPAR 1410
M16	1500	41	2.59	10	RRTPAR 1415
M16	2000	41	3.47	10	RRTPAR 1420
M20	300	41	0.8	7	RRTPAR 1730
M20	500	41	1.34	7	RRTPAR 1750
M20	1000	41	2.68	7	RRTPAR 1710
M20	1500	41	4.02	7	RRTPAR 1715
M20	2000	41	5.36	7	RRTPAR 1720

Material: Copper

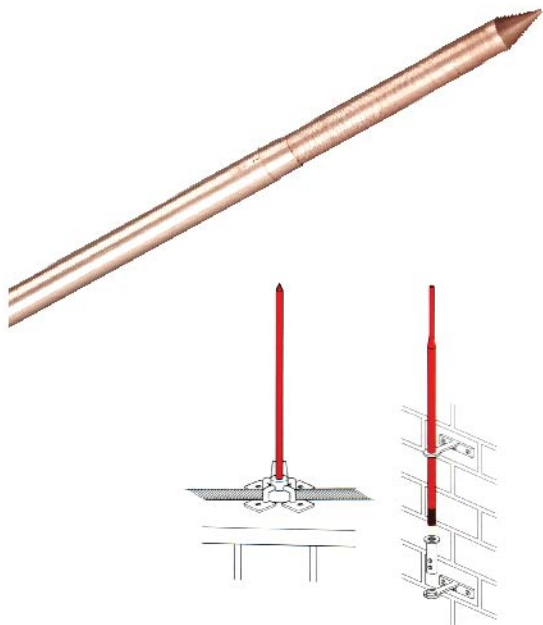
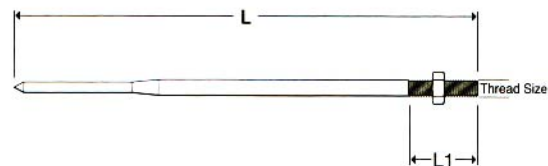

Multi-Point

Used in conjunction with taper pointed copper air rods

Air Rod Dia. mm	H mm	W mm	Unit Weight Kg.	Pack Quantity	Part Number
16 & 20	156	72	0.3	5	RRMUP

Material: Brass / Copper

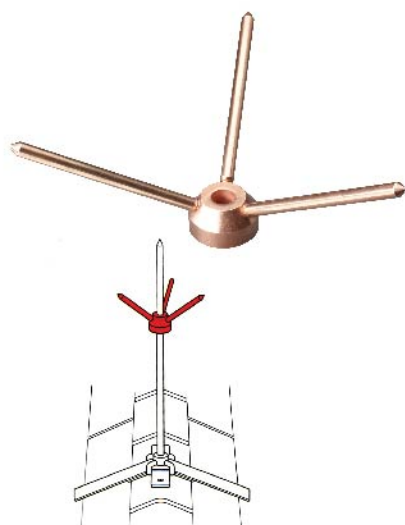
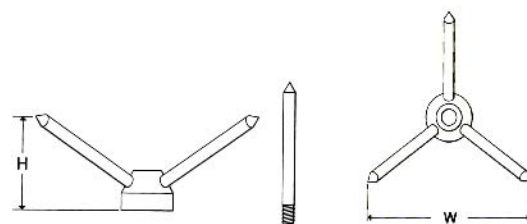

Side Mounting Air Rod Brackets

- Used where it is not possible to fit saddle onto building roof
- Used in conjunction with rod to tape coupling, to secure flat tape to air rod
- Provide a 75mm projection from the building face

For use with Copper Air Rods

Rod Dia mm	L mm	W mm	Unit Weight Kg.	Pack Quantity	Part Number
16	97	120	0.39	10	RRARB 16
20	97	120	0.43	10	RRARB 20

Material: Brass and Gunmetal

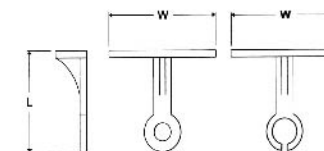
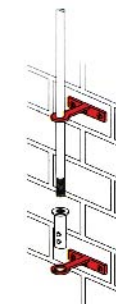

Rod to Cable Coupling

- Enables stranded cable to be connected to air rod
- Used in conjunction with side mounting air rod bracket

Conductor Size mm	Thread Size	L mm	D mm	Unit weight kg.	Pack Quantity	Part Number
50	M16	80	40	0.24	25	RRRCC 50
70	M16	80	40	0.24	25	RRRCC 70

Material: Brass and Gunmetal

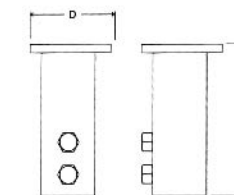

One Hole Cable Clips

- Offer ease in fixing stranded copper conductors to surfaces
- Provide easy method of fixing copper and aluminium conductors to surfaces
- Fixed using round head wood screw 1 1/2"

For use with Copper Air Rods

Conductor Size mm ²	L mm	W mm	H mm	Unit Weight Kg.	Pack Quantity	Part Number
6	10	10	5	0.01	100	RROHCC 6
10	10	10	5	0.01	100	RROHCC 10
16	15	10	5	0.01	100	RROHCC 16
25	15	10	8	0.01	100	RROHCC 25
35	18	10	8	0.01	100	RROHCC 35
50	18	10	10	0.01	100	RROHCC 50
70	22	10	10	0.01	100	RROHCC 70
95	22	10	13	0.01	100	RROHCC 95
120	25	15	15	0.01	100	RROHCC 120
150	25	15	15	0.02	100	RROHCC 150
185	30	15	20	0.02	100	RROHCC 185
240	30	20	20	0.02	100	RROHCC 240
300	35	20	25	0.02	100	RROHCC 300

Material: Copper

For use with PVC Insulated Stranded Copper Conductor

Conductor Size mm ²	L mm	W mm	H mm	Unit Weight Kg.	Pack Quantity	Part Number
6	10	10	5	0.01	100	RROHCC 6 P
10	10	10	7	0.01	100	RROHCC 10 P
16	15	10	7	0.01	100	RROHCC 16 P
25	15	10	10	0.01	100	RROHCC 25 P
35	18	10	10	0.01	100	RROHCC 35 P
50	18	10	15	0.01	100	RROHCC 50 P
70	22	10	15	0.01	100	RROHCC 70 P
95	22	10	15	0.01	100	RROHCC 95 P
120	25	15	20	0.01	100	RROHCC 120 P
150	25	15	20	0.02	100	RROHCC 150 P
185	30	15	25	0.02	100	RROHCC 185 P
240	30	20	25	0.02	100	RROHCC 240 P
300	35	20	30	0.02	100	RROHCC 300 P

Material: Copper

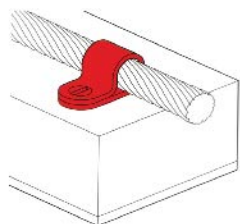
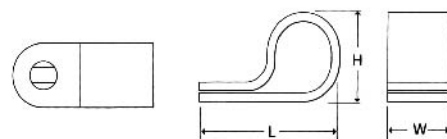

Metallic Cable Clips

- Used to secure circular down conductors to building surfaces
- Fixed using counter sunk wood screw 1.5" x No.10 and No. 10 wall plug

For use with Bare Stranded Copper Conductor

Conductor Size mm ²	L mm	W mm	H mm	Unit Weight Kg.	Pack Quantity	Part Number
6	35	15	12	0.03	75	RRMCC 6
10	35	15	12	0.03	75	RRMCC 10
16	35	15	15	0.04	75	RRMCC 16
25	35	15	15	0.04	75	RRMCC 25
35	46	17	17	0.05	75	RRMCC 35
50	46	17	17	0.05	75	RRMCC 50
70	46	17	19	0.06	50	RRMCC 70
95	46	17	21	0.06	50	RRMCC 95
120	60	20	23	0.07	50	RRMCC 120
150	60	20	23	0.07	50	RRMCC 150
185	60	20	26	0.08	50	RRMCC 185
240	60	20	29	0.09	50	RRMCC 240
300	60	20	31	0.09	50	RRMCC 300

Material: Brass and Gunmetal

For use with Insulated Stranded Copper Conductor

Conductor Size mm	L mm	W mm	H mm	Unit Weight Kg.	Pack Quantity	Part Number
6	35	15	14	0.03	75	RRMCC 6 P
10	35	15	14	0.03	75	RRMCC 10 P
16	35	15	17	0.04	75	RRMCC 16 P
25	35	15	17	0.04	75	RRMCC 25 P
35	46	17	19	0.05	75	RRMCC 35 P
50	46	17	19	0.05	75	RRMCC 50 P
70	46	17	21	0.06	50	RRMCC 70 P
95	46	17	22	0.06	50	RRMCC 95 P
120	60	20	25	0.07	50	RRMCC 120 P
150	60	20	26	0.07	50	RRMCC 150 P
185	60	20	28	0.08	50	RRMCC 185 P
240	60	20	31	0.09	50	RRMCC 240 P
300	60	20	32	0.09	50	RRMCC 300 P

Material: Brass and Gunmetal

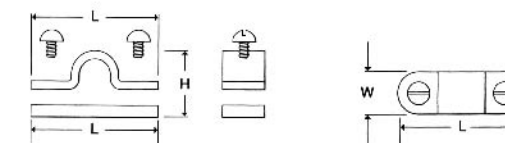
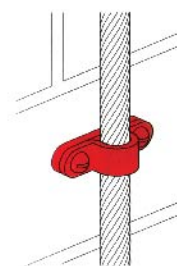



Square Cable Clamps

- Four way connectors, suitable for making cross, straight tee or through joints in stranded copper conductor

For use with Copper Air Rods

Conductor Size mm ²	L mm	W mm	H mm	Unit Weight Kg.	Pack Quantity	Part Number
50	50	50	30	0.3	30	RRSCC 50
70	53	53	33	0.27	30	RRSCC 70
95	55	55	35	0.22	30	RRSCC 95

Material: Brass and Gunmetal

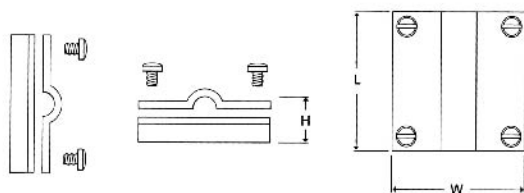
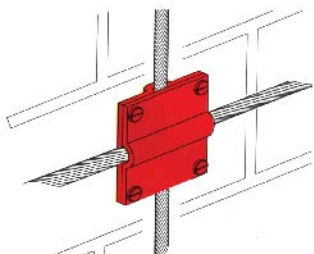

Air Rod Cable Saddles

- Used to support copper taper pointed air rods on flat roof surfaces
- Ensures proper connection of air rods with circular conductor

Conductor Size mm ²	Thread Size	L mm	W mm	H mm	Unit Weight Kg.	Pack Quantity	Part Number
50	M16	85	85	65	1.05	10	RRARCS 50
70	M16	85	85	65	1	10	RRARCS 70
95	M16	85	85	65	0.9	10	RRARCS 95

Material: Brass and Gunmetal

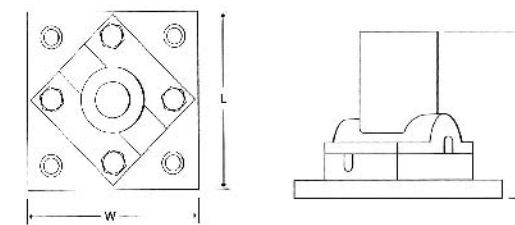
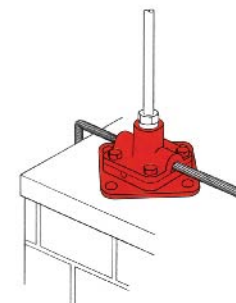

Tower Earth Clamps

- Double plate ensures proper bonding of stranded copper conductors onto steel surface
- Fixed by drilling a screw to steel surface

For use with Bare Stranded Copper Conductor

Conductor Range mm ²	L mm	W mm	H mm	Set Screw	Pack Quantity	Part Number
16 - 70	45	30	17	M10x50mm	20	RRTEC 070
70 - 120	48	35	22	M12x60mm	20	RRTEC 120
120 - 185	55	40	28	M12x75mm	20	RRTEC 185
185 - 240	63	45	35	M12x80mm	20	RRTEC 240
240 - 300	70	53	42	M12x90mm	20	RRTEC 300

Material: Brass and Gunmetal

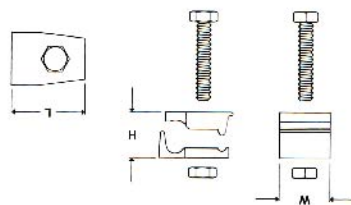
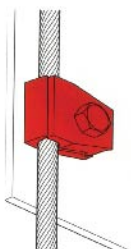

Cable to Tape Connectors

- Four way connector clamps, suitable for crossing over flat tape and solid circular conductor

For use with Bare Copper Conductors

Conductor Size mm	L mm	W mm	H mm	Unit Weight Kg.	Pack Quantity	Part Number
50	52	52	14	0.28	20	RRSCTC 2550
70	54	54	16	0.33	20	RRSCTC 2570
95	56	56	18	0.39	20	RRSCTC 2595

Material: Brass and Gunmetal

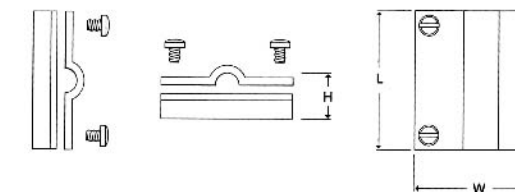
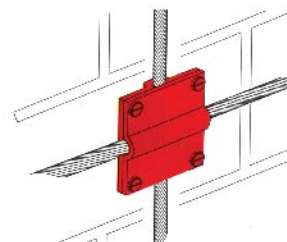



PROVIDING CONNECTIVITY, ENSURING STABILITY!

Conductors are an essential part of any Earthing and Lightning Protection System.

They are used to join conductive surfaces and ensure that the electrical circuit is not broken.

1. INTRODUCTION _____ 62
2. FLAT TAPE SYSTEM _____ 64
3. SOLID CIRCULAR SYSTEM _____ 70
4. CABLE AND WIRE SYSTEM _____ 71

RR offers an extensive range and variety of conductors, such as flat and circular conductor systems in copper as well as in aluminium, which conform to European, British and world earthing and lightning protection standards.

Various aspects need to be considered while selecting a down conductor. It should be seen that the conductor is resilient to the environmental conditions in which it is to be installed. The conductor should be capable of withstanding mechanical damage and corrosion. It should also be compatible with the material of other connected components.

It should also be seen that the conductor has a sufficient cross-sectional area to be capable of carrying, without sustaining damage or deterioration, any currents that may reasonably be expected.

Copper Conductor Ratings

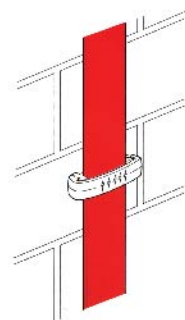
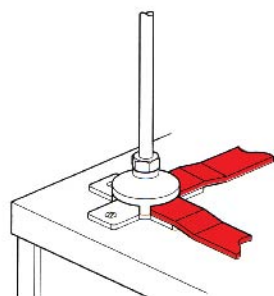

- Shown in the table below are fault current capacities, for one and three second durations, for a wide selection of standard sizes of copper tapes
- These conductor ratings are based on recommendations of BS 7430 with an initial conductor temperature of 30° C and maximum temperature of 250° C

Conductor Size mm	C.S.A mm ²	KA for 1 second	KA for 3 seconds
20 x 3	60	10.6	6.1
25 x 3	75	13.2	7.6
25 x 6	150	26.4	15.2
30 x 2	60	10.6	6.1
30 x 3	90	15.8	9.1
38 x 3	114	20.1	11.6
40 x 3	120	21.1	12.2
40 x 5	200	35.2	20.3
40 x 6	240	42.2	24.4
50 x 3	150	26.4	15.2
50 x 6	300	52.8	30.5

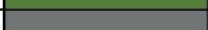

PVC covered Copper Conductors

- PVC covered copper tape and solid circular conductors are available in different colours
- These can be manufactured in accordance with customer's colour specifications

BLACK	18B29*	
GREEN	06C39*	
GREY	00A07*	
WHITE	10B15*	
BROWN	BS 6746 C	

*PVC COLOURS TO BS 5252

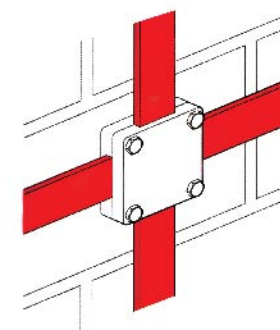
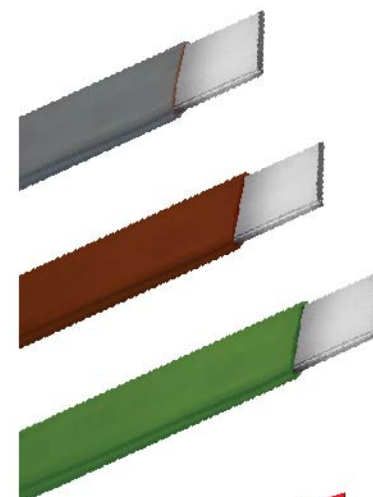

Bare Copper Tapes

- High conductivity tape, used in both, earthing protection and lightning protection applications
- Annealed for ease of use
- Has round edges
- All our standard bare copper tapes are marked, RR Copper BS EN 13601

Size W x H mm	C.S.A mm ²	Weight per Meter kg appx	Standard Coil Size m	Part Number
20 x 1.5	30	0.27	100	RRCT 2015
20 x 3	60	0.53	50	RRCT 203
25 x 2	50	0.445	50	RRCT 252
25 x 3	75	0.67	50	RRCT 253
25 x 6	150	1.33	25	RRCT 256
30 x 2	60	0.53	50	RRCT 302
30 x 3	90	0.8	50	RRCT 303
30 x 6	180	1.6	20	RRCT 306
31 x 3	93	0.83	25	RRCT 313
31 x 6	186	1.65	25	RRCT 316
38 x 3	114	1.01	25	RRCT 383
38 x 6	228	2.02	20	RRCT 386
40 x 3	120	1.06	25	RRCT 403
40 x 6	240	2.16	20	RRCT 406
50 x 3	150	1.33	20	RRCT 503
50 x 5	250	2.22	20	RRCT 505
50 x 6	300	2.68	20	RRCT 506

Material: Copper to BS EN 13601

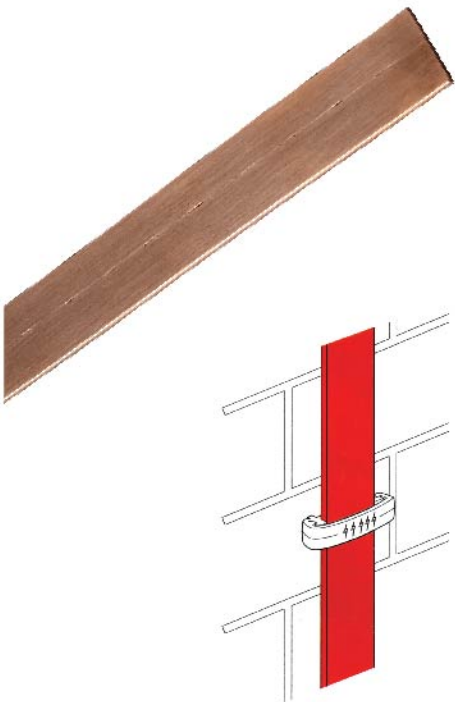
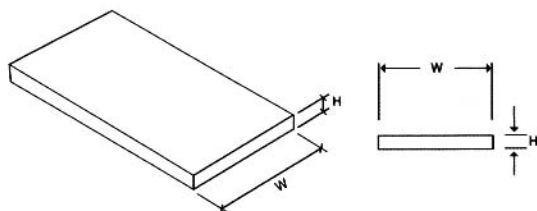

PVC Covered Copper Tapes

- Used as down conductors on a building's structural Lightning Protection System
- The copper used is manufactured to BS EN 13601 and is annealed for ease of use
- Colour is based on customer's requirement and is however, subject to Minimum Order Quantity
- Standard colours are shown in the table below
- Other colours are available on request subject to minimum order quantity

Size W x H mm	Colour	C.S.A mm ²	Weight per Meter kg appx	Standard Coil Size m	Part Number
25 x 3	Green	75	0.77	25 & 50	RRCTP 253G
25 x 3	Brown	75	0.77	25 & 50	RRCTP 253B
25 x 3	White	75	0.77	25 & 50	RRCTP 253 W
25 x 3	Black	75	0.77	25 & 50	RRCTP 253 BL
25 x 3	Grey	75	0.77	25 & 50	RRCTP 253 GR
25 X 6	Green	150	1.53	40	RRCTP 256 G
50 X 3	Green	150	1.53	40	RRCTP 503 G
50 X 6	Green	300	2.95	25	RRCTP 506 G

Material: Copper to BS EN 13601
PVC Colours to BS 5252 except Green

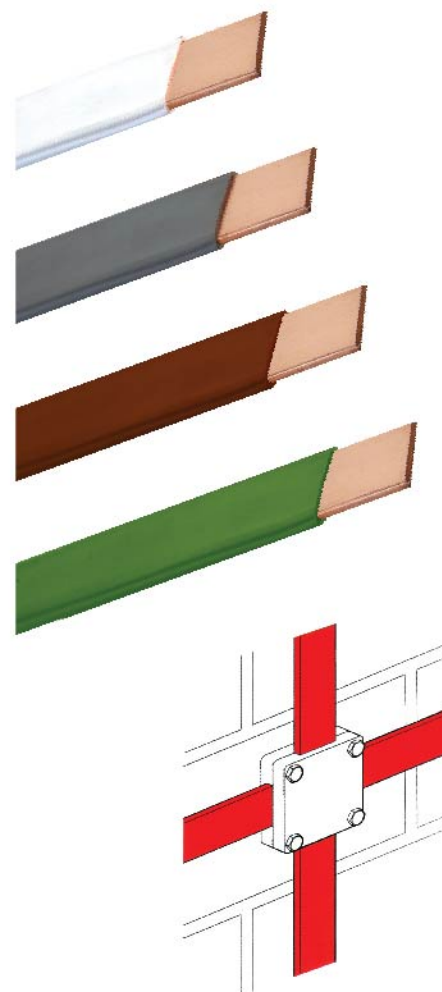
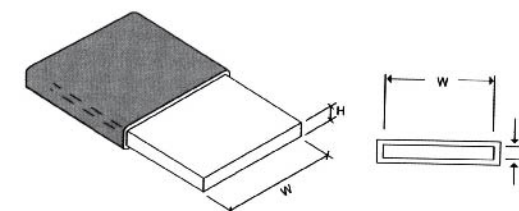

Green & Yellow PVC Insulated Copper Tapes



Size W x H mm	C.S.A mm ²	Weight per Meter kg appx	Standard Coil Size m	Part Number
25 x 3	75	0.79	25 & 50	RRCTP 253 GY

Material: Copper to BS EN 13601
PVC Colour to BS 6746 C

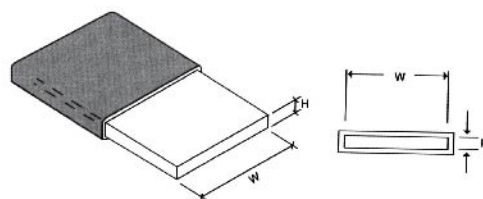

Tinned Copper Tapes

- Made from electrolytic grade copper
- Tin plating done through continuous plating process

Size W x H mm	C.S.A mm ²	Weight per Meter kg appx	Standard Coil Size m	Part Number
20 x 1.5	30	0.27	100	RRCT 2015 T
20 x 3	60	0.53	50	RRCT 203 T
25 x 2	50	0.445	50	RRCT 252 T
25 x 3	75	0.67	50	RRCT 253 T
25 x 6	150	1.33	25	RRCT 256 T
30 x 2	60	0.53	50	RRCT 302 T
30 x 3	90	0.8	50	RRCT 303 T
30 x 6	180	1.6	20	RRCT 306 T
31 x 3	93	0.83	25	RRCT 313 T
31 x 6	186	1.65	25	RRCT 316 T
38 x 3	114	1.01	25	RRCT 383 T
38 x 6	228	2.02	20	RRCT 386 T
40 x 3	120	1.06	25	RRCT 403 T
40 x 6	240	2.16	20	RRCT 406 T
50 x 3	150	1.33	20	RRCT 503 T
50 x 5	250	2.22	20	RRCT 505 T
50 x 6	300	2.68	20	RRCT 506 T

Material: Copper to BS EN 13601

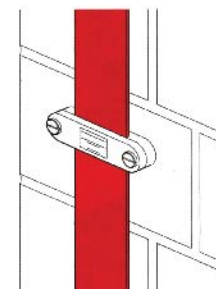

LSOH covered Copper Tapes

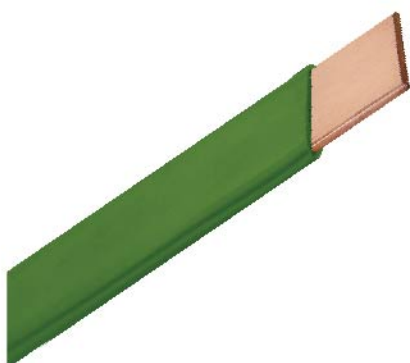

Size W x H mm	Colour	C.S.A mm ²	Weight per Meter kg appx	Standard Coil Size m	Part Number
25 x 3	Green	75	0.77	25 & 50	RRCTL 253
25 x 6	Green	75	1.53	40	RRCTL 256
50 x 6	Green	75	2.95	20	RRCTL 506

Material: Copper to BS EN 13601
PVC Colour to BS 6746 C

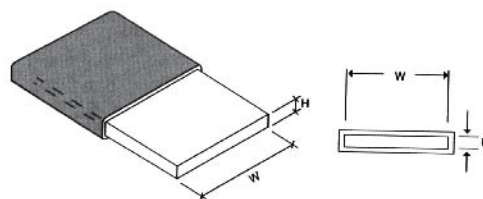

Bare Aluminium Tapes

- Used as down conductor on a buildings structural Lightning protection System.
- High conductivity tape , used in both , earthing protection and lightning protection applications.
- Annealed for ease of use.



Size W x H mm	C.S.A mm ²	Standard Coil Size m	Part Number
20 x 1.5	30	50	RRAT 2015
20 x 3	60	50	RRAT 203
25 x 3	75	50	RRAT 253
30 x 2	60	50	RRAT 302
30 x 3	90	25	RRAT 303
40 x 3	120	25	RRAT 403
40 x 6	240	25	RRAT 406
50 x 6	300	20	RRAT 506

Bare Hard Drawn Copper Bars

Size W x H mm	C.S.A mm ²	Weight per Meter kg appx	Standard Coil Size m	Part Number
20 x 3	60	0.534	3	RRHDCB 203
25 x 3	75	0.6675	3	RRHDCB 253
25 x 4	100	0.89	3	RRHDCB 254
25 x 6	150	1.335	3	RRHDCB 256
38 x 6	228	2.0292	3	RRHDCB 386
50 x 6	300	2.67	3	RRHDCB 506
75 x 6	450	4.005	3	RRHDCB 756
80 x 5	400	3.56	3	RRHDCB 805
80 x 6	480	4.272	3	RRHDCB 806
100 x 5	500	4.45	3	RRHDCB 1005
100 x 6	600	5.34	3	RRHDCB 1006

Material: Copper to BS EN 13601

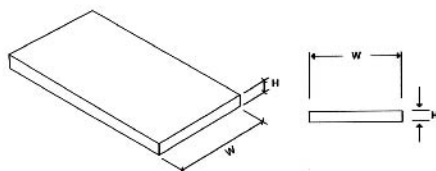

Bare Copper Flat Flexible Braids

- Used as flexible earth bonding leads
- Standard sizes and constructions are shown below
- Other sizes and constructions are available on request

Nominal C.S.A mm ²	Nominal Size W x H mm	Braid construction	Current Rating Amps	Weight per Meter kg.	Standard Coil size m	Part Number
6	12 x 1.0	24/8/0.2 mm	66	0.06	100	RRFCB 6
10	15 x 1.5	48/7/0.2 mm	90	0.1	100	RRFCB 10
16	19 x 2.5	48/11/0.2 mm	120	0.16	50	RRFCB 16
25	23 x 2.0	48/17/0.2 mm	160	0.25	50	RRFCB 25
35	25 x 3.5	48/23/0.2 mm	200	0.34	50	RRFCB 35
50	30 x 5.0	48/33/0.2 mm	250	0.48	50	RRFCB 50
70	32 x 6.0	48/46/0.2 mm	300	0.63	50	RRFCB 70

Material: Copper Wire to BS EN 13602



Tinned Hard Drawn Copper Bars

Size W x H mm	C.S.A mm ²	Weight per Meter kg appx	Standard Coil Size m	Part Number
20 x 3	60	0.534	3	RRHDCB 203 T
25 x 3	75	0.6675	3	RRHDCB 253 T
25 x 4	100	0.89	3	RRHDCB 254 T
25 x 6	150	1.335	3	RRHDCB 256 T
38 x 6	228	2.0292	3	RRHDCB 386 T
50 x 6	300	2.67	3	RRHDCB 506 T
75 x 6	450	4.005	3	RRHDCB 756 T
80 x 5	400	3.56	3	RRHDCB 805 T
80 x 6	480	4.272	3	RRHDCB 806 T
100 x 5	500	4.45	3	RRHDCB 1005 T
100 x 6	600	5.34	3	RRHDCB 1006 T

Material: Copper to BS EN 13601

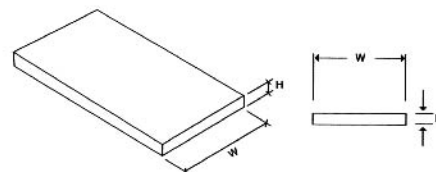

Tinned Copper Flat Flexible Braids

- Used as flexible earth bonding leads, with additional corrosion protection
- Standard sizes and constructions are shown below
- Other sizes and constructions are available on request

Nominal C.S.A mm ²	Nominal Size W x H mm	Braid construction	Current Rating Amps	Weight per Meter kg.	Standard Coil size m	Part Number
6	12 x 1.0	24/8/0.2 mm	66	0.06	100	RRFCB 6T
10	15 x 1.5	48/7/0.2 mm	90	0.1	100	RRFCB 10T
16	19 x 2.5	48/11/0.2 mm	120	0.16	50	RRFCB 16T
25	23 x 2.0	48/17/0.2 mm	160	0.25	50	RRFCB 25T
35	25 x 3.5	48/23/0.2 mm	200	0.34	50	RRFCB 35T
50	30 x 5.0	48/33/0.2 mm	250	0.48	50	RRFCB 50T
70	32 x 6.0	48/46/0.2 mm	300	0.63	50	RRFCB 70T

Material: Copper Wire to BS EN 13602



Bare Solid Circular Copper Conductor

- 8mm diameter solid circular conductor, used in Lightning Protection Systems
- Annealed for ease of use

D mm	C.S.A mm	Weight per Meter kg.	Standard Coil Size m	Part Number
8	50.27	0.44	50	RRCWR 8

Material: Copper to BS EN 13601

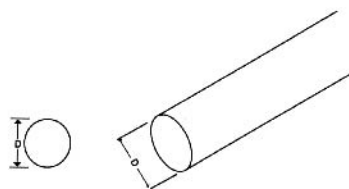
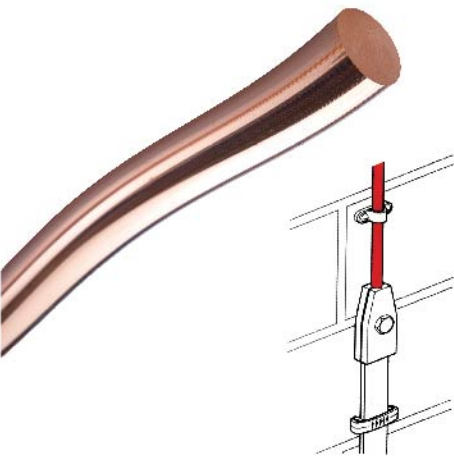

Bare Stranded Copper Conductors

- Used in both, Lightning Protection and Earthing Systems
- Available as both, soft drawn and hard drawn

Soft drawn

C.S.A mm ²	Stranding No. X Ø mm	Nominal Ø mm	Maximum Resistance 20° C Ω/ km	Weight per Meter kg.	Part Number
6	7 x 1.04	3.12	3.08	0.05	RRSCC 6
10	7 x 1.35	4.05	1.83	0.09	RRSCC 10
16	7 x 1.70	5.10	1.15	0.15	RRSCC 16
25	7 x 2.14	6.42	0.72	0.23	RRSCC 25
35	19 x 1.53	7.65	0.52	0.32	RRSCC 35
50	19 x 1.78	8.90	0.38	0.43	RRSCC 50
70	19 x 2.14	10.70	0.26	0.62	RRSCC 70
95	19 x 2.52	12.60	0.19	0.86	RRSCC 95
120	37 x 2.03	14.21	0.15	1.09	RRSCC 120
150	37 x 2.25	15.75	0.12	1.33	RRSCC 150
185	37 x 2.52	17.64	0.09	1.67	RRSCC 185
240	61 x 2.25	20.25	0.07	2.20	RRSCC 240
300	61 x 2.52	22.68	0.06	2.76	RRSCC 300
400	61 x 2.85	25.65	0.04	3.53	RRSCC 400

Material: Copper to BS EN 60228 : 2005

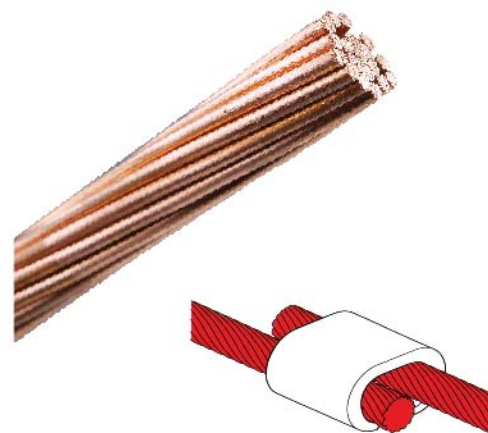

Hard drawn

C.S.A mm ²	Stranding No. X Ø mm	Nominal Ø mm	Maximum Resistance 20oC Ω/ km	Weight per Meter kg.	Part Number
35	7 X 2.52	7.65	0.54	0.32	RRSCCH 35
50	7 X 3.00	8.9	0.399	0.43	RRSCCH 50
70	7 X 3.55	10.72	0.276	0.62	RRSCCH 70
95	37 X 1.78	12.6	0.199	0.86	RRSCH 95

Material: Copper to BS EN 60228 : 2005



PVC Covered Solid Circular Copper Conductors

- Used as down conductors in a building's structural Lightning Protection System
- PVC covering ensures safety

D mm	Colour	C.S.A mm	Weight per Meter kg.	Standard Coil Size m	Part Number
8	White	50.27	0.44	50	RRCWR 8 W
8	Grey	50.27	0.44	50	RRCWR 8 G
8	Black	50.27	0.44	50	RRCWR 8 BL
8	Brown	50.27	0.44	50	RRCWR 8 B

Material: Copper to BS EN 13601
PVC colours to BS 5252

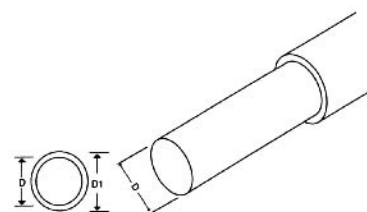

Green & Yellow PVC Insulated Stranded Copper Conductors

- Range of single core stranded class 2 plain annealed copper conductors, with heat resistant PVC outer sheath
- Non-armoured single insulation cables are often referred to as 6491X and are manufactured as per BS 6004

C.S.A mm ²	Stranding No. X Ø mm	Nominal Ø mm	Maximum Resistance 20°C Ω/ km	Weight per Meter kg	Part Number
6	7 x 1.04	4.80	3.080	0.07	RRGYC 6
10	7 x 1.35	6.10	1.830	0.12	RRGYC 10
16	7 x 1.70	7.10	1.150	0.19	RRGYC 16
25	7 x 2.14	8.90	0.727	0.29	RRGYC 25
35	19 x 1.53	10.10	0.524	0.41	RRGYC 35
50	19 x 1.78	11.80	0.387	0.53	RRSCC 50
70	19 x 2.14	13.60	0.268	0.73	RRGYC 70
95	19 x 2.52	15.90	0.193	1.00	RRGYC 95
120	37 x 2.03	17.50	0.153	1.16	RRGYC 120
150	37 x 2.25	19.40	0.124	1.54	RRGYC 150
185	37 x 2.52	21.70	0.099	2.01	RRGYC 185
240	61 x 2.25	24.50	0.075	2.49	RRGYC 240
300	61 x 2.52	27.50	0.060	3.05	RRGYC 300
400	61 x 2.85	30.90	0.047	3.90	RRGYC 400

Material: Copper to BS EN 60228 : 2005
PVC Colour to BS 6746C

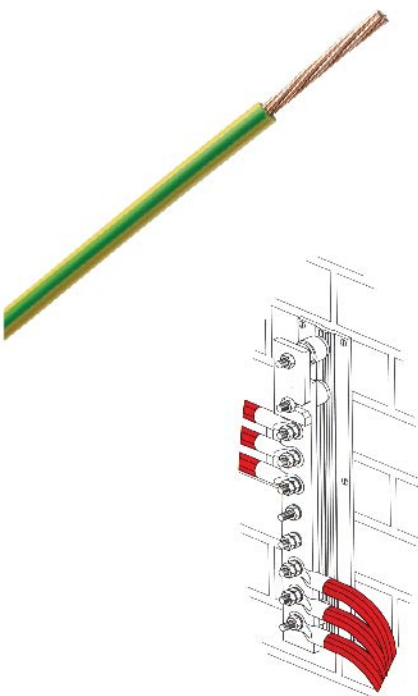

Tinned Stranded Copper Conductors

C.S.A mm ²	Stranding No. X Ø mm	Nominal Ø mm	Maximum Resistance 20°C Ω/ km	Weight per Meter kg.	Part Number
6	7 x 1.04	3.12	3.110	0.05	RRSCC 6
10	7 x 1.35	4.05	1.840	0.09	RRSCC 10
16	7 x 1.70	5.10	1.160	0.15	RRSCC 16
25	7 x 2.14	6.42	0.734	0.23	RRSCC 25
35	19 x 1.53	7.65	0.529	0.32	RRSCC 35
50	19 x 1.78	8.90	0.391	0.43	RRSCC 50
70	19 x 2.14	10.70	0.270	0.62	RRSCC 70
95	19 x 2.52	12.60	0.195	0.86	RRSCC 95
120	37 x 2.03	14.21	0.154	1.09	RRSCC 120
150	37 x 2.25	15.75	0.126	1.33	RRSCC 150
185	37 x 2.52	17.64	0.100	1.67	RRSCC 185
240	61 x 2.25	20.25	0.076	2.20	RRSCC 240
300	61 x 2.52	22.68	0.061	2.76	RRSCC 300
400	61 x 2.85	25.65	0.048	3.53	RRSCC 400

Material: Copper to BS EN 60228 : 2005

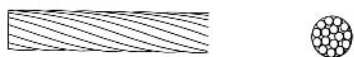

Bare Copper Round Braids

- Utilized as flexible earth bonding leads
- Standard sizes and constructions are shown below
- Other sizes and constructions can also be manufactured as per customer specifications

Nominal C.S.A mm ²	Nominal Ø mm	Wire Strand Ø mm	Current Rating Amps	Weight per Meter kg	Standard Coil Size m	Part Number
6	5.0	0.15	69	0.05	100	RRCRB 6
10	7.0	0.15	97	0.08	100	RRCRB 10
16	8.0	0.15	132	0.13	50	RRCRB 16
25	10.0	0.15	178	0.22	50	RRCRB 25
35	12.0	0.15	223	0.30	50	RRCRB 35
50	15.0	0.15	282	0.44	50	RRCRB 50

Material: Copper wire to BS EN 13602

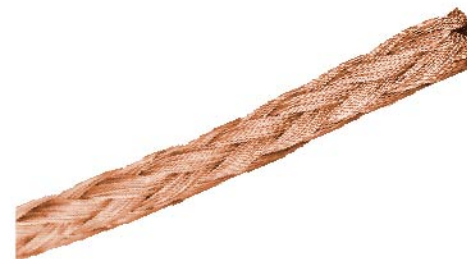

Tinned Copper Round Braids

- Utilized as flexible earth bonding leads, with additional corrosion protection
- Standard sizes and constructions are shown below
- Other sizes and constructions can also be manufactured as per customer specifications

Nominal C.S.A mm ²	Nominal Ø mm	Wire Strand Ø mm	Current Rating Amps	Weight per Meter kg	Standard Coil Size m	Part Number
6	5.0	0.15	69	0.05	100	RRCRB 6 T
10	7.0	0.15	97	0.08	100	RRCRB 10 T
16	8.0	0.15	132	0.13	50	RRCRB 16 T
25	10.0	0.15	178	0.22	50	RRCRB 25 T
35	12.0	0.15	223	0.30	50	RRCRB 35 T
50	15.0	0.15	282	0.44	50	RRCRB 50 T

Material: Copper wire to BS EN 13602

