

WIRE MESH TRAY TECHNICAL GUIDE



Cablofil

Cablofil

POWER



DATA



CONTROL PROCESS



Technical Guide

Cablofil - the global solution

THE FIRST NAME IN WIRE CABLE TRAY

Over 35 years ago, Cablofil invented the concept of wire cable tray and introduced it to the European market. The company's continued success is the result of on-going innovation and the ability of wire cable tray to adapt to any application. Since then Legrand®/Cablofil has become a leader in cable management around the world with more than 94,000 miles of tray installed globally. Today the company is continuing to develop new labor-saving products and installation techniques that are changing the way cables are supported in every aspect of the global electrical market.

COMMITMENT TO THE NORTH AMERICAN MARKET

Over ten years ago, Cablofil was one of the first wire cable tray manufacturers to market in the US, Mexico and Canada. Since then, demand for wire cable tray has expanded rapidly and in 2001, Cablofil demonstrated its commitment to the North American electrical market by establishing a 78,000 sq. ft. dedicated manufacturing facility in Mascoutah, Illinois. This is the largest production facility of any basket tray manufacturer in North America and houses our US headquarters, a state-of-the-art assembly area with centralized warehousing and shipping. With this commitment, we have emerged as the US leader in product innovation, quality control and timely delivery.

Applications - Sustainable Development

PAGES 4-5

Loading and Supports

PAGES 6-7

Materials and Finishes

PAGES 8-9

Food Industry Safety

PAGES 10-11

Electromagnetic Interference

PAGES 12-13

Electrical Continuity

PAGES 14

Grounding and Bonding

PAGES 15

Energy Savings

PAGES 16

Short Circuit Testing

PAGES 17

Efficient Data Cabling

PAGE 18

Fiber Optic Data Cables

PAGE 19

Copper Data Cables

PAGE 20-21

Standards and Directives

PAGES 22-23

Fire Resistance

PAGES 24-25

Fire Protection: Flamestopper

PAGES 26-27

References

PAGE 28

Decision-Making Software

PAGE 29

Specifications

PAGE 30

Applications

BUILDING SERVICES



- Hospitals
- Shopping centers
- Offices / Hotels
- Data centers / Technology centers
- Museums
- Schools / Universities

INFRASTRUCTURE



- Airports
- Stations
- Tunnels
- Bridges
- Stadia
- Telecommunications

HEAVY INDUSTRY



- Mines / Quarries
- Steel
- Cement
- Petrochemicals
- Oil and gas
- Energy production

PROCESSING INDUSTRIES



- Chemicals / Pharmaceuticals
- Automotive / Equipment
- Glass / Wood / Textiles / Paper
- Food industry
- Water and waste treatment
- Ships / Platforms

Sustainable Development

Sustainable development, once the preserve of legislators and governments, has become a fact of life for all stakeholders within society. Today's project managers, whether in an industrial, services or infrastructure context, need to respect the environment and consider the human impact of their actions. CABLOFIL® is fully aware of these issues and behaves responsibly across all its sites and organizational structures. Legrand also extends this approach to its partners, with a view to developing a lasting commitment in this area.

PRODUCTION DESIGN

- Health and environment
- 100% recyclable steels
- Improving use of raw materials by 20%
- Reducing carbon footprint associated with manufacturing and transportation
- Ensuring surface treatments comply with the RoHS Directive

IMPROVED ENERGY EFFICIENCY

- Continuous improvement of manufacturing processes - ISO 9001
- Improving installation time and energy consumption on-site
- Reducing electricity consumption by improving cable ventilation



SITE MANAGEMENT: ISO 14001



ISO 14001

- Raising awareness among personnel of environmental management at sites
- Reducing noise pollution through the use of sound-proof rooms
- Ensuring more than 50% of industrial waste is recycled, with no use of landfill
- Retaining, filtering and treating fumes
- Controlling water consumption - closed cooling system



Cablofil

Loading and Supports

First and foremost, a cable tray must act as an effective and durable support for cables. The mechanical performance of cable tray products and accessories are tested against the demanding requirements imposed by the NEMA VE-1 Underwriters Laboratories (UL) and international standard IEC 61537. These standards help ensure cable tray systems safety support cabling in a wide variety of applications.

LOAD TESTING

Legrand/Cablofil WMCT has been engineered and tested per NEMA VE-1 to support loads that exceed its fill capacity. For additional data on load capacities and test methods, please visit www.legrand.us/cablofil.

LOAD TABLE

Cablofil Tray	Fill Area	Loads in LBS/FT Per Span			
		5'	6'	7'	8'
CF30/50(1x2)	2.17"	-	-	-	-
CF30/100(1x4)	4.34"	-	-	-	-
CF30/150(1x6)	6.51"	-	-	-	-
CF30/200(1x8)	8.68"	-	-	-	-
CF30/300(1x2)	13.02"	-	-	-	-
CF54/50(2x2)	4.03"	32	15.1	11.1	9.1
CF54/100(2x4)	8.06"	39.4	22.3	16.4	15.9
CF54/150(2x6)	12.09"	46.5	27.6	20.3	19.1
CF54/200(2x8)	16.12"	54.2	36.4	26.7	24.7
CF54/300(2x12)	24.18"	71.6	47.1	34.6	31.7
CF54/400(2x16)	32.24"	134.9	91.0	66.8	60.3
CF54/450(2x18)	36.27"	134.9	91.0	66.8	60.3
CF54/500(2x20)	40.30"	119.4	95.4	70.1	62.8
CF54/600(2x24)	48.36"	119.4	95.4	70.1	62.8
CF105/100(4x4)	15.97"	68.3	46.4	34.1	30.5
CF105/150(4x6)	23.95"	98.4	60.2	44.3	40.9
CF105/200(4x8)	31.93"	109.4	76.2	56.0	51.9
CF105/300(4x12)	47.90"	142.0	126.8	93.1	89.2
CF105/400(4x16)	63.86"	151.0	129.9	95.4	88.7
CF105/450(4x18)	71.84"	151.0	129.9	95.4	88.7
CF105/500(4x20)	79.83"	151.0	129.9	95.4	88.7
CF105/600(4x24)	95.79"	151.0	129.9	95.4	88.7
CF150/150(6x6)	34.41"	127.5	123.0	90.4	89.1
CF150/200(6x8)	45.88"	127.5	123.0	90.4	89.1
CF150/300(6x12)	68.82"	175.9	155.0	113.9	98.3
CF150/400(6x16)	91.76"	175.9	155.0	113.9	98.3
CF150/450(6x18)	103.23"	175.9	155.0	113.9	98.3
CF150/500(6x20)	114.70"	228.5	165.7	121.7	91.3
CF150/600(6x24)	137.64"	228.5	165.7	121.7	91.3

SAFE WORKING LOAD (SWL) OF CABLOFIL SUPPORTS ACCORDING TO IEC 61537 LOAD TESTING

Product Category	Product Description	Part No.	SWL (daN)	SWL (lbs)	
Wall Supports	CS Bracket	CS100	72	158	
		CS200	67	147	
		CS300	70	154	
	CSC Bracket	CSC100	35	77	
		CSC200	35	77	
		CSC300	32	70	
	FAS P Profile	FAS600	280	616	
	FAS L Bracket	FASL100	130	286	
		FAS L150	110	242	
		FAS L200	85	187	
		FAS L300	65	143	
	FAS C Bracket	FAS C100	120	264	
		FAS C200	80	176	
		FAS C300	50	110	
	FAS Universal Bracket	FAS U100	30	66	
		FAS U150	70	154	
		FAS U200	80	176	
		FAS U300	80	176	
		FAS U400	110	242	
	CRP Reinforced Bracket	FAS U500	150	330	
CRP 400		280	616		
CRP 500		260	572		
CRP 600	CRP 600	320	704		
	Ceiling Supports	AS Trapeze Hanging Clip	AS B	100	220
		SAS Hanger Bracket	SAS B	60	132
Threaded Rod	1/4"	THRD 1/4	107	240	
	3/8"	THRD 3/8	325	730	
	1/2"	THRD 1/2	601	1350	

Safe Working Load (SWL) Calculation:

SWL = Load applied along bracket = Width of bracket (W)/divided by 20 W/20 is maximum acceptable deflection, for example 12"/20 = 0.6" of deflection maximum.

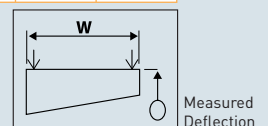

SAFETY

In the event of critical overload, a mesh structure becomes like a hammock.

CABLOFIL is only designed to support cables. Under no circumstances should it be used as a walkway.



SAFE WORKING LOADS

While many Legrand/Cablofil supports utilized our Fast Assembly System (FAS) which offer simple one-step locking tabs that require no additional hardware to secure WMCT to supports, our WMCT have been tested to UL, CSA, NEMA VE-1 and IEC standards. Cablofil wire mesh tray and supports are designed to support any cable load allowed by the NEC when supports are spaced on 8' spans. Only the heaviest cables (750 kcmil multiconductor power or larger) may require shorter spans. For specific loading go to the interactive table on www.legrand.us/cablofil and choose your exact cable for detailed cable capacity and span requirements.

POSITIONING OF THE SPLICE (general scenario applicable to all spans)

To get the best performance from tray, choosing the right couplers is just as important as their positioning. CABLOFIL couplers have been designed and tested to provide high levels of mechanical and electrical performance. To maximise performance, follow the recommendations below:

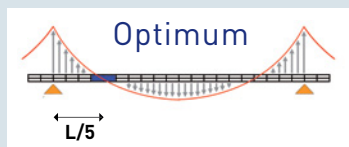

100% PERFORMANCE
For best results, place the couplers at 1/5th of the way along the span.

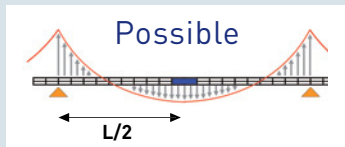

70% PERFORMANCE
If the coupling is at L/2, a coefficient of 0.7 should be applied to the permissible load.



Never put the support under coupler.

POSITIONING OF THE SUPPORTS

Changes of level and direction:

Put supports in place before there is any deflection of the cable tray route. It is recommended to place supports at the start and end of 90° bends. A support must be positioned in the middle of large-radius bends.

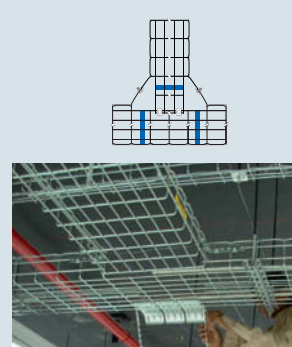
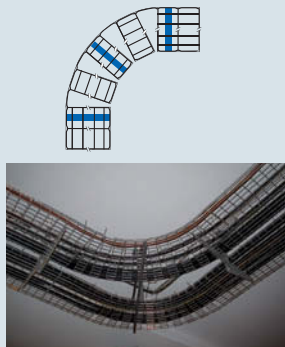
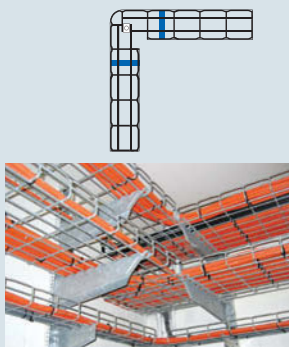
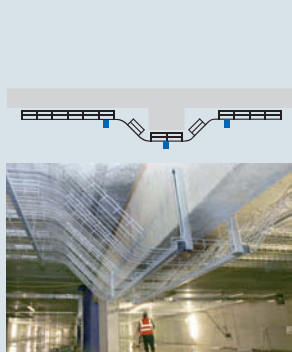

Materials and Finishes

Uncontrolled corrosion is a recurrent problem with all applications involving metals, it may lead to a reduction in the performance and lifetime of the installation. Cable trays are mainly exposed to atmospheric corrosion. The environment in which the cable trays are installed is therefore the main criteria in the choice of surface treatment, or type of steel.

Atmospheric corrosion affecting metals involves a chemical reaction between the iron found in steel and dioxygen in

air or water (condensed moisture, rain or spray). The reaction produces the chemical compound $Fe(OH)_3$, more commonly known as rust.

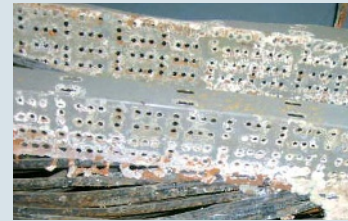

COATED STEELS

Galvanic protection of steel is a sacrificial process. Zinc, in contact with an oxidising agent, is converted into zinc hydrocarbonate (white) thus protecting the steel.

<input type="radio"/> Recommended <input checked="" type="radio"/> Possible	PG	EZ	GC	DC	304L	316L
Indoor installation, controlled environment	○	○				
Outdoor installation, urban environment			○	○		
Chemical industries, nitrate explosives			◆	◆		○
Marine, sulphurous environment			◆	◆		○
Acid or alkaline environments			◆	◆	◆	○
Food production environment					○	○
Halogen environment					◆	○

Steel Grade Quality

Our tray is constructed of precision engineered, high quality steel wire. ISO 9000 certified, Legrand/Cablofil wire cable tray is subjected to rigorous quality control at every stage of the manufacturing processes.

EZ Electrogalvanising after manufacture

ASTM A633 standard

The cable tray, manufactured using untreated steel wire, is pickled and then immersed in an electrolyte containing zinc. Zinc is then deposited on it by passing an electric current. A smooth blue-grey, fairly glossy appearance is obtained to a greater or lesser extent depending on the pH value of the electrolytic bath used. The color and level of gloss have no negative or positive effect on the corrosion resistance of the coating.

> Ongoing protection

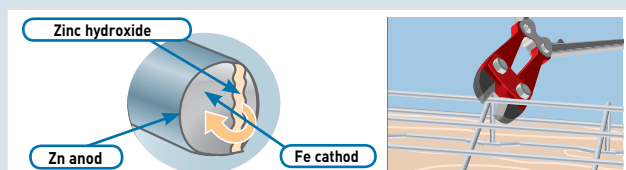

When a wire cable tray is cut, the fact that a wire has been cut does not affect the level of protection. The jaws of the bolt cutter drags a layer of zinc across the cut end and forms a protective layer.

GC Hot dipped galvanized after manufacture

ASTM A123 standard

The cable trays or accessories, manufactured from untreated steel sheet or wire, are degreased and pickled before being immersed in a bath of molten zinc. The entire product is therefore covered with a thick layer of zinc.

A light grey, rough appearance is obtained.

NOTE: Any white marks due to the formation of zinc hydroxycarbonate which might appear on the surface have no influence on the corrosion resistance.

DC Geomet®

ASTM F1136 standard

Geomet® is a treatment based on zinc and aluminium. As it does not contain any chromium VI (hexavalent), it complies with the RoHS Directive.

Offering protection equivalent to GC, it is used for small accessories and fixings which are difficult to hot dip galvanize.

BL PE Powder Coated Paint

ASTM D3451 standard

Resin-based paint is applied to the cable tray using an electrostatic powder and then cured in an oven. Black is standard. The entire range of colors are available. Mainly used for aesthetic reasons and to help identify cable routes, it offers very good corrosion resistance and the industries only UL classified painted tray system.

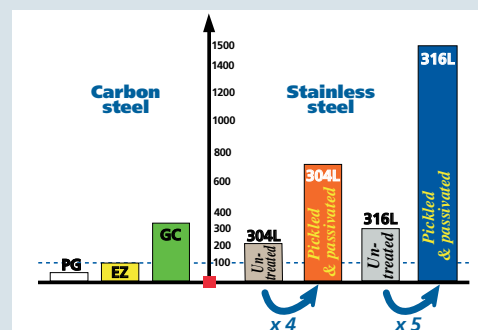

Figures for salt spray tests, baseline 100: EZ

STAINLESS STEELS

In particularly harsh environments, selecting the right type of steel is more important than the coating. CABLOFIL uses two austenitic stainless steels, 304 L and 316 L, for their high level of corrosion resistance. This is partly the result of their very low carbon levels ("L" stands for "low carbon") as well as a Cablofil exclusive passivation process.

304L **Stainless steel 304 L** ASTM A380 standard
AISI 304L – X2CrNi18.09

Offers good corrosion resistance against soft water, normal environments and food products (except mustard and white wine).

316L **Stainless steel 316 L** ASTM A380 standard
AISI 316L – X2CrNiMo17.12.2

Since it contains molybdenum, stainless steel 316L is able to resist intergranular corrosion. This makes it particularly suitable for the chemical and food industries, the nitrate explosives industry and environments containing halogen (fluorine and chlorine).

> Decontamination of stainless steels

There are two key stages for prolonging the service life of the product and, by implication, the installation:

- **Pickling** in acid after degreasing eliminates pollutants.
- **Passivation** artificially creates a film of chromium oxide on the surface of the steel.

Corrosion-resistance tests involving salt spray and SO₂ (sulphur dioxide) highlight the importance of these two processes.

Pickling and passivation give CABLOFIL's stainless steel a very clean uniform and a distinctly matte finish.

All CABLOFIL stainless steel products are pickled and passivated.



Untreated

Pickled and passivated

Untreated

Pickled and passivated

GALVANIC CORROSION

Partner metal →
Metal involved ↓

	Stainless steel	Nickel	Copper	Brass	Tin	Steel	Aluminium	Chromium	Zinc
Stainless steel	0								
Nickel	180								
Copper	320	140	0						
Brass	400	220	80	0					
Tin	550	370	230	150	0				
Steel	750	570	430	350	200	0			
Aluminium	840	660	520	440	290	90	0		
Chromium	950	770	630	550	400	200	110	0	
Zinc	1150	970	830	750	600	400	310	200	0

Differences in potential are expressed in millivolts.
Beneath the red line, the metal involved is attacked.

Corrosion is the result of an electrochemical phenomenon caused by a difference in potential between different metals, or between a metal and the impurities within it when they are connected electrically.

It is important to understand this phenomenon if you want to be sure of selecting the best supports, fixings and earthing terminals. This will ensure that surface treatments are compatible:

Wire cable trays		Accessories
EZ/PG	→	EZ/GS
GC	→	GC/DC
304L	→	304L & 316L
316L	→	316L

Food Industry Safety

Safety in the food processing industry is critical. Production lines must be kept clean. Even the smallest risk of contamination can result in operational losses and have dramatic repercussions for public health and a company's image.

NSF DIRECTIVES

NSF directives set out methods and principles for managing food safety. The entire production process is subjected to a program of detailed and continuous analysis. Each stage of the various processes involved is scrutinized to identify any critical points and eliminate any potential dangers.

COMPLETE FOOD SAFETY

CABLOFIL's structure (90% is completely open), with its smooth rounded wires and T-welded safety edge, minimizes the risk of dust and debris settling on surfaces.

Whether installed horizontally or sideways, CABLOFIL's transparency and excellent cable spacing make it easy to inspect the installation and check whether it is clean. Any animal matter or bacterial growth can be identified at an early stage.

Any pollution or unwanted proliferation can be eliminated by blowing, vacuuming or power cleaning. These steps can be taken on a regular basis or after inspections.

Similarly, all CABLOFIL accessories (brackets, spacers, couplers) have been designed with the aim of reducing dust and debris retention.

When installed sideways, Cablofil's structure further reduces the surface area on where dust and debris can settle. Conduits and wireways trap contaminants making them difficult to clean. They also provide hidden pathways for insects or vermin.

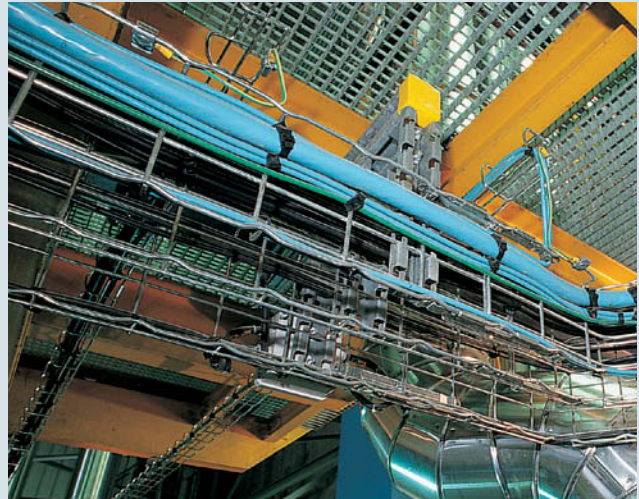
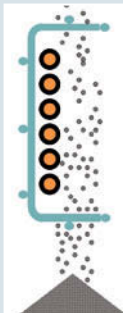

Sideways



On conveyors



On vats and silos

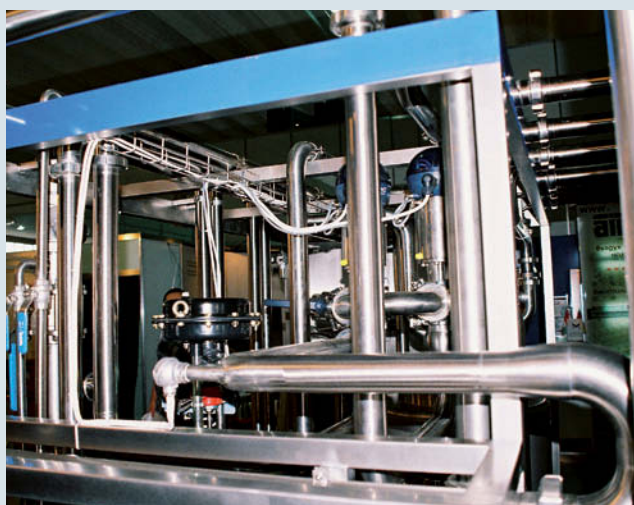

Welded onto machine frames

AN ADAPTABLE SYSTEM

Thanks to its wide product range and numerous screwless accessories, CABLOFIL does not require any dedicated tools and quickly adapts to any installation method.

PREMIUM SERVICE

CABLOFIL is the world's leading wire cable tray and the preferred cable routing method of the major players in the food industry. It can be delivered quickly and is available either direct from the factory or from distributors. Specialist engineers offer advice on which products and installation method to choose, and can even help end-users design a specific solution.



DURABILITY GUARANTEED

CABLOFIL has two low-carbon stainless steel ranges (304L and 316L). These are pickled and passivated after manufacture, and are easily identified by their ID Tags. These alloys are highly resistant to the corrosion associated with cleaning processes or agents. As a result, CABLOFIL's installations are designed to last longer.



Cablofil

Electromagnetic Interference

Understanding EMI involves the analysis of electromagnetic pollution between a source of disturbance and its victim.

THE EMI

Electromagnetic interference is emitted by a source polluting a victim. Electromagnetic interference is transmitted by a process known as coupling. An EMI problem only occurs when the three elements source, coupling and victim are evident. To obtain a good EMI we simply need to eliminate one of the three elements or reduce its effect.

Metallic cable trays with excellent electrical continuity which are integrated into an installation's equipotential earthing network reduce the effects of coupling and therefore improve an electrical installation's EMI.

Source

Coupling

Victim

Sources include frequency modulators, mobile phones, lightning, power cables, transformers, etc.

Victims include IT systems, devices, DATA cables, etc.

THE CABLOFIL® SOLUTION

- It's open structure makes it easy to ensure correct separation by visual inspection.
- It's easy installation and metal structure guarantee excellent electrical continuity in all cases: couplings, bends, level changes, crossing walls, etc.
- It's open structure can reduce crosstalk.

BEST PRACTICES FOR REDUCING EMI

Remember the importance of keeping power and data cables separate.*

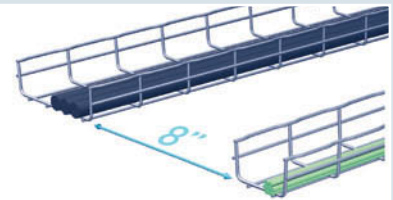

Make sure different cable types cross at right angles.

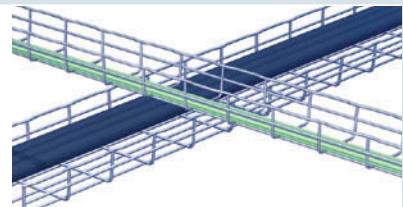

Make sure electrical continuity is preserved: Use metal cable tray and UL classified splices.



Connect cable trays to the earthing network (every 60').

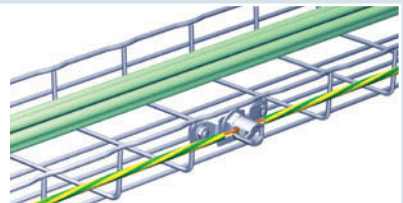

* BICSI standard specifies how far cables must be kept apart. This depends on the type of data cable, the number of power cables and the type of cable tray. Otherwise, the distance of 8" provides a simple and sensible rule of thumb. For precise details, please contact our technical support service.

EMC TESTS

Tests conducted by the accredited and independent AEMC Measures and CETIM laboratories demonstrate the performance of CABLOFIL in regard to the EMI of the electrical installation.

EXCELLENT

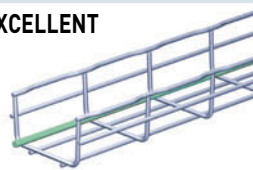

Excellent EMC performance
Cable arrangement can be inspected visually.

POSSIBLE

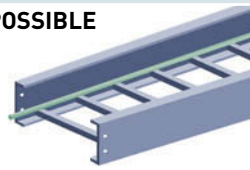

Similar performance to wire cable trays,
visual inspection

NOT RECOMMENDED



Do not mix power and data cables in the same enclosed compartment

When integrated into the earthing network, CABLOFIL's metallic cable trays help electrical installations achieve excellent EMI levels.

DATA CABLE IN AN EXTERNAL ELECTROMAGNETIC FIELD



A data cable (Category 5e UTP) is placed in an insulated anechoic chamber and subjected to a powerful artificially-generated electromagnetic field in order to simulate electromagnetic interference.

Each tray is connected to earth and subjected to the test:

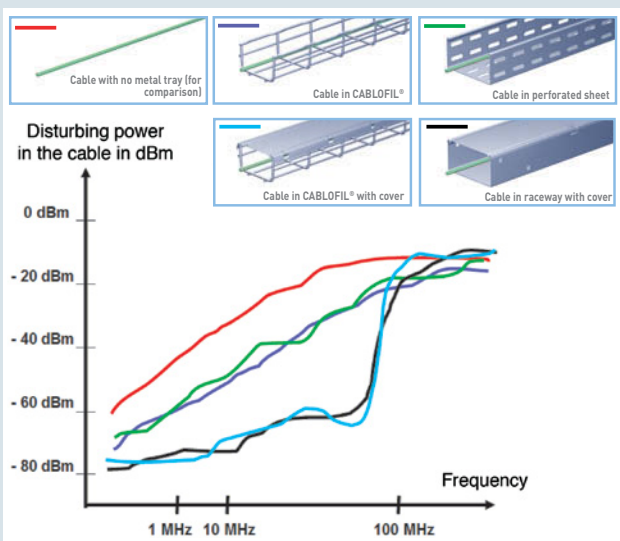

> Results and interpretations

A simple comparison of the measurements for the different cable tray configurations (wire mesh and perforated tray, with and without cover) makes it possible to quantify the role played by the tray in terms of EMI.

These tests show that there is no significant difference in «Faraday cage» effect offered by wire mesh or perforated cable tray.

These results show that it is vital:

- Use metal tray
- Earth the cable tray
- Use a cover if required



Non metallic and non-ferrous cable trays (PVC, aluminum composite materials) are ineffective against electromagnetic interference.

DATA CABLE ALONGSIDE A POWER CABLE



A Category 6 UTP data cable is placed inside an insulated anechoic chamber and subjected to an electromagnetic field generated by a power cable. The following parameters are studied:

- Cable-tray earthing
- Separation distances: 0, 25, 50, 75 ft
- Cable-tray type: wire mesh, perforated tray, trunking
- Separated cable trays
- One cable trays, with and without dividers

As a result, a total of 118 configurations are tested.

Generation of electromagnetic interference by injecting current into the power cable

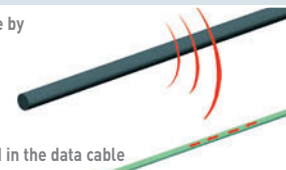

Measurement of the interference generated in the data cable

A comparison of the impact of 3 of the 118 configurations

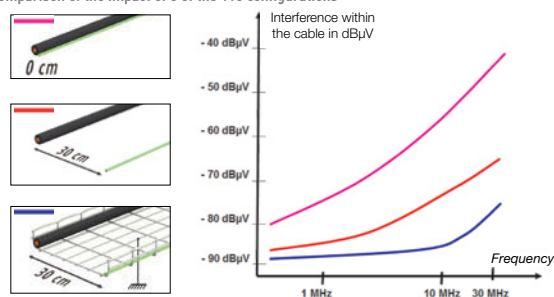

> Results and interpretations

This second test configuration confirms that metal cable trays reduce interference (wire mesh or perforated tray).

To obtain a good EMI, these results show that it is vital:

- Use metal cable tray
- Earth the cable tray

These tests show the importance of the following criterias:

- Ensure maximum separation distances
- Use two separate cable trays for power and data
- Use a divider if sharing containment systems



Never put power cables and data cables in the same closed compartment.

Electrical Continuity

Fundamental to providing safety to people and property, electrical continuity also plays an essential role in the EMI performance of an electrical installation.

DEFINITION

The electrical continuity of a system is its ability to conduct electric current. Each system is characterized by its resistance R .

If $R = 0 \Omega$, the system is a perfect conductor.

If R is infinite, the system is a perfect insulator.

The lower the system's resistance, the better its electrical continuity will be.

Guarantee the safety of people and property: avoiding any risk of electrocution.

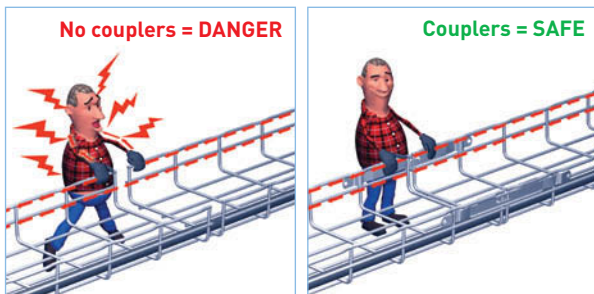

THE IMPORTANCE OF HAVING EXCELLENT ELECTRICAL CONTINUITY

Even at the same electrical potential each part of the cable tray helps dissipate any fault currents:

Promotes good EMI within an installation: by dissipating noise currents generated by interference.

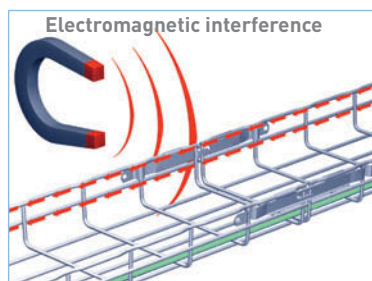

The metal structure of the cable tray absorbs some of the electromagnetic disturbance and converts it into noise current.

TESTED FOR ELECTRICAL CONTINUITY

CABLOFIL couplers

NEMA VE-1/CSA and UL standards state that coupler resistance must not exceed $.33 \text{ m}\Omega$. The test involves running an electric current \rightarrow through the system (cable trays + couplers) and measuring coupler resistance \square .

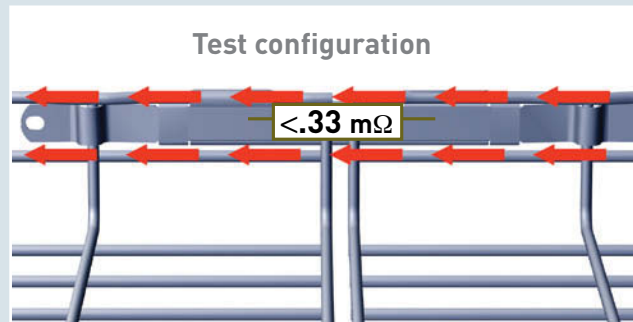

TEST RESULTS

Most CABLOFIL couplers are tested and compliant, see catalog or website for a complete listing of types and compliance.

Please contact our technical support service for the full results of these tests or information on stainless steel.

Grounding & Bonding

Earthing⁽¹⁾ an installation is vital for the safety of people and property. Furthermore it plays an active role in EMI.

⁽¹⁾Also referred to as "grounding"

DEFINITION

The earth network is made up of all the metallic components of a building that are interconnected. These include beams, conduits, cable trays, the metal frames or devices. All such elements must be interconnected to ensure the earth network is equipotential.

BONDING AND GROUNDING

Per NEC 392, the national electrical code section for cable tray, all cable tray systems must be properly BONDED, per section 259.96. To meet this requirement, Cablofil recommends that UL classified splices are used to join sections and that the cable tray be bonded to building steel or the facility grounding system every 50'-60". By bonding the tray every 50'-60", the tray will maintain a low potential to ground which reduces EMI and provides a continuous path for stray currents. Steel trapeze type hangers clamped securely to building steel usually provide a solid bond. Cablofil standard splices (SWK, EDNRN, EZBN, EDT, EZT90, RADT90) are designed to have less than 1 milliohm of resistance between connections and provide bonding between sections. These splices have been tested by UL as part of the cable tray grounding system. Painted Cablofil wire mesh tray requires the outer mask of the conductive surface be removed at each end of the tray prior to installing the (SWK) splice. This (SWK) splice provides a UL Classified Bonding continuity between painted tray sections. All cable tray needs to be electrically continuous per NEC 250.96. Standard Cablofil splices provide continuity per 250.96. Cutting and removal of cable tray sections still allow continuity per 250.96 and only affects the rare use of cable tray as the EGC. Use of cable tray as an EGC is rare since UL requires all multiconductor cables to contain an integral EGC and single conductor cables are only used in a few industrial applications.

Data Cables

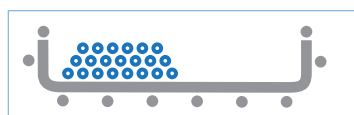

Tray bonded per NEC 250.96 with UL splices

Multi Conductor Power Cables

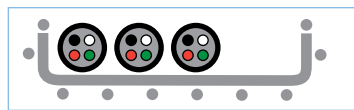

Tray bonded per NEC 250.96 with UL splices

Single Conductor Power Cables

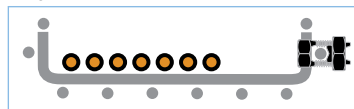

Tray bonded with continuous ground wire sized per max breaker

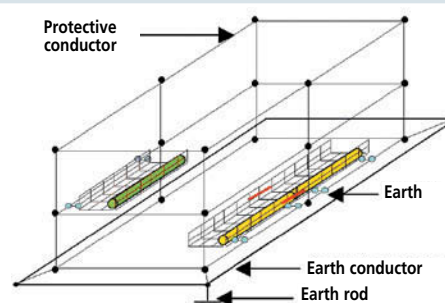

DEDICATED ACCESSORIES

First and foremost, the installer must establish the cross section for the protective conductor. CABLOFIL offers a wide range of dedicated accessories:



GNDCL: Simple and cost-effective earthing connector made of tin-plated aluminium. Used for protective conductors with a cross section of between 6 and 35 mm².



GNDSB: Use one GNDSB every 60' and/or at the end of each cable tray run. If cable tray is used as an Equipment Grounding Conductor, use one on each section of tray for a code compliant installation.

Cablofil

Energy Savings

Electricity transfer generates energy losses in the form of heat. By reducing the operating temperature of the power cables substantial savings can be made. The open structure of CABLOFIL® maximizes ventilation and therefore reduces installation and operational costs.

ASSESSMENT

When an electrical current is running, the copper or aluminium cable cores heat up. The heat given off, known as the Joule effect, is caused by the resistivity of the material (its ability to resist the passage of an electric current).

This resistivity increases with temperature. If confined, the heat given off will increase the ambient temperature, thereby increasing both resistivity and resistance. To enable the required current to flow, more power will have to be supplied, with more energy being wasted. The resistance R of a conductor (cable) is proportional to the resistivity ρ of the material, based on cross section (S) and length (L). $R = \rho \times \frac{L}{S}$

Power P dissipated by the Joule effect: $P = R \times I^2$, where I is the current's intensity.

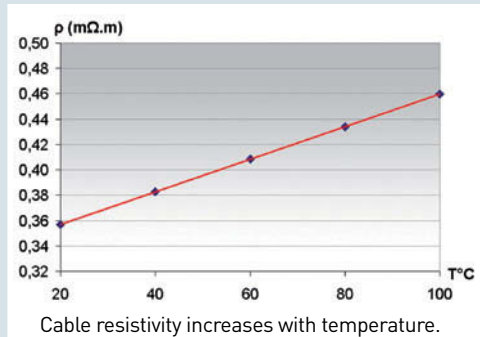

SOLUTIONS

- Increase the cross section of cables to reduce resistance.
- Ventilate cables to reduce heating.

As 90% of its structure is open, CABLOFIL is the closest solution to running a cable in free air and, in many cases, the standards do not make a distinction between the two. The NEC section 392.11(B) 3 allows cables to be run at free air ampacities, over 35% more amps than cable in a raceway.

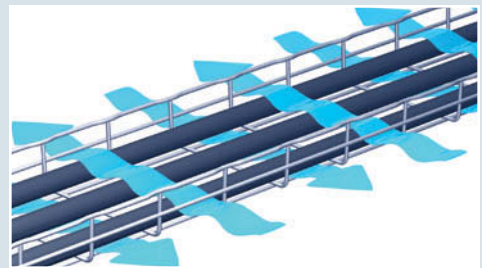

ENERGY SAVING EVALUATIONS

The following tests were conducted at Bureau Veritas - LCIE to compare the affect on cable performance by different cable tray systems.

Power cables are fed a steady current. Energy consumption is compared for different configurations. The test results show that consumption differs significantly between open and closed systems.

The graph below shows how the choice of system can affect overconsumption of electricity (by as much as 37%).

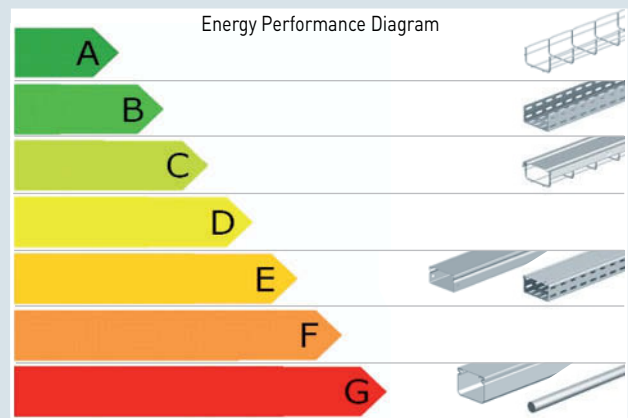
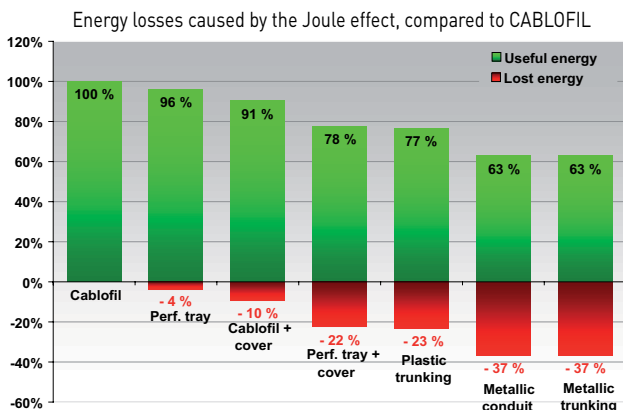

Short Circuit Testing

In spite of the electrical protection equipment of the network, energy transfer will always present risks to people and property. CABLOFIL® is able to manage these risks with its high performance cable supports.

SHORT CIRCUITS

A short circuit occurs when a connection is accidentally established between two points in an electric circuit at different voltages.

It presents a risk to both property and people.

Depending on where it occurs, very large currents may be generated, which will often result in a fire.

The main causes of short circuits are as follows:

- Damage to insulating material as a result of wear and tear or mechanical impact
- Broken conductors
- Conducting elements falling onto or otherwise coming into contact with the circuit

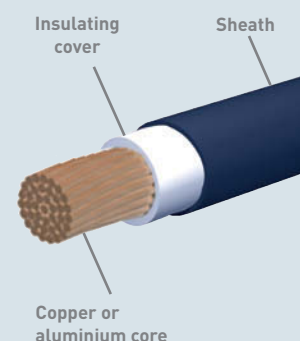

SHORT CIRCUIT TESTS

Tests were performed at a recognized independent laboratory (DAMSTRA) and in accordance to standard EN 50 368 (2003) in order to validate CABLOFIL's mechanical resistance to the stress generated by a short circuit.

An initial short circuit is generated during the tests, creating mutual electromagnetic repulsion between the power cables.

The cable tray is then subjected to substantial mechanical stress for a very short time (approx. one second). The process is repeated in order to show that CABLOFIL is structurally intact and able to cope with another short circuit. As a final measure, additional tests are performed in a damp environment to check whether the cables are fully intact.

The various tests are run with 3 successive levels of short-circuit current:

- 70 kA, equivalent to a repulsive force of 1300 daN
- 100 kA, equivalent to a repulsive force of 2700 daN
- 130 kA, equivalent to a repulsive force of 4500 daN

Material used: 3 m of CF105/450, coupling 1/5th of the way along the span, 5 EDRN couplers and a support span of 1.5 meters.

System configuration: 3 single-conductor power cables, 38 mm in diameter, are attached every 600 mm using cleats.



Before test



During test

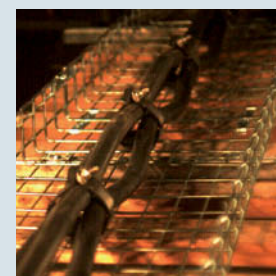

After test

CONCLUSION

The tests reveal that the wire cable tray shows no permanent deformation, its mesh structure is able to absorb the physical stress generated by a significant short-circuit current.

The cables remain intact in their original positions and network availability is maintained.

Video available at www.legrand.us/cablofil

Class Intensity	Class 1	Class 2
70 kA	✓	✓
100 kA	✓	✓
130 kA	✓	✓

Efficient Data Cabling

In order to manage data installations and master their complexity, it is necessary to have a high performance cabling system which has the capacity to evolve. With the relevant standards in mind, CABLOFIL® helps design, organize and arrange a variety of cabling systems, while also ensuring system safety.

DATA SECURITY AND INTEGRITY

To preserve transmission integrity of a data cable, its sheath needs to be respected as well as the geometry of its section. Similarly, it must only be subjected to limited mechanical stress during installation work.



Cables should be placed in, rather than dragged into, the cable tray. Using dedicated accessories (e.g. FAS-ROLLER) combined with CABLOFIL's T-welded safety edge and rounded wires reduces the risk of kinking and tearing.

Whether bundled together or layed flat, the cables should not be tied too tightly, and tools should not be used. CABLOFIL recommends the FASTIE or CABLOSNAP products.

Due to its natural flexibility, CABLOFIL is able to support the bend radius specified by cable manufacturers. The CABLEXIT, ensures that the bend radius of the cable is respected.

The cable tray's metallic structure and perfect electrical continuity, combined with a high-quality earth network, provides effective defense against electromagnetic interference.

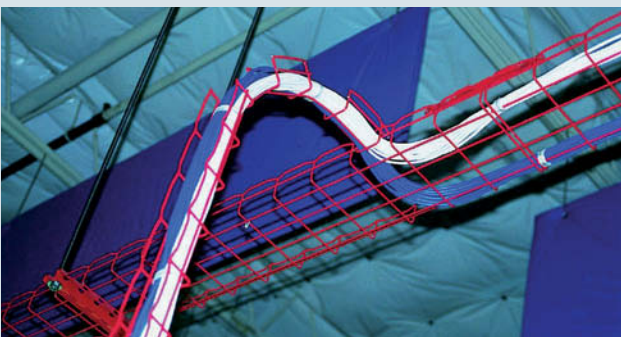

MAINTAINING AND DEVELOPING THE INSTALLATION

CABLOFIL's transparency makes it easier to identify, arrange and monitor networks. The available space for adding new cables is easy to see and reach.



The use of identification tags or epoxy coating the trays helps to identify cable routes and enables networks to be upgraded more quickly.

COST MANAGEMENT

CABLOFIL's cost effective solutions and quick to install products, can be used in any configuration (false floors, false ceilings and cabinets) and furthermore the adaptability of this open system reduces maintenance costs.

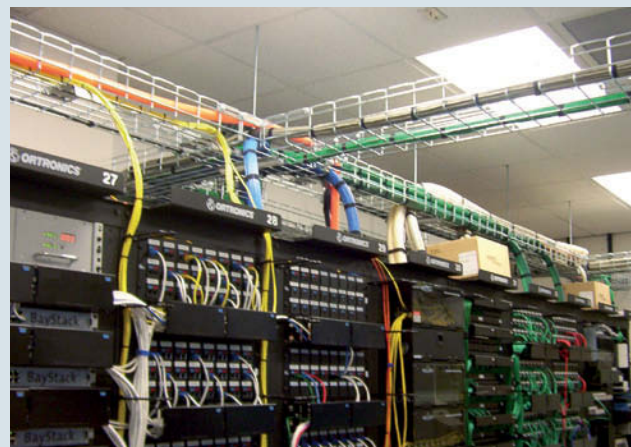

Fiber Optic Data Cables

The development of fiber optics is a direct result of the growing demand for fast data transmission between different terminals. Given its immunity to electromagnetic interference and its characteristics in terms of signal transmission, fiber optics are the ideal support for high-speed data transmission.

DEFINITION

The optical fiber is a very thin glass cable transmitting light signals on which digital data is carried. The transmission factor for fiber optics, expressed in decibels (dB), gives its data-transmission quality.

TYPES OF FIBER OPTIC

> Single-mode fiber optic



The core is very thin and enables light to flow in what is practically a straight line. This type of fiber is frequently used for telecom services, connections over very long distances (several miles) and in backbones (a term used to refer to the "nerve centre" of a high-speed network).

Categories	OS1
Diameter	9/125 μm
Throughput	≥ 10 Gbits/s
Bandwidth	≥ 25 Gbits.km

> Multi-mode, step-index fiber optic

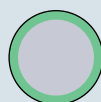

The core is thicker than the cladding. This type of fiber is very effective over short distances, but is not often used.

> Multi-mode, graded-index fiber optic

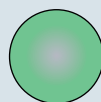

The core and the cladding form successive layers of glass. It is frequently used for medium distances, local networks and the main cable routes inside buildings.

Categories	OM1	OM2	OM3
Diameter	62.5/125 μm	62.5/125 μm , 50/125 μm	50/125 μm
Throughput	100 Mbits/s to 1 Gbit/s	≤ 1 Gbit/s	≤ 10 Gbits/s
Bandwidth for 850 nm	200 MHz.km	500 MHz.km	1500 MHz.km
Bandwidth for 1350 nm	500 MHz.km	500 MHz.km	500 MHz.km

COMPONENTS OF A FIBER OPTIC CABLE

Optical waves spread along the optical core made of silica, melted quartz or plastic. The core diameter ranges from 50 μm to 200 μm .

The optical cladding ensures the optical waves remain in the core. The light ray spreads as it is repeatedly reflected against the barriers formed by the optical cladding.

The protective covering, usually a plastic layer with a thickness of between 25 and 1000 microns, gives the fiber excellent mechanical properties.

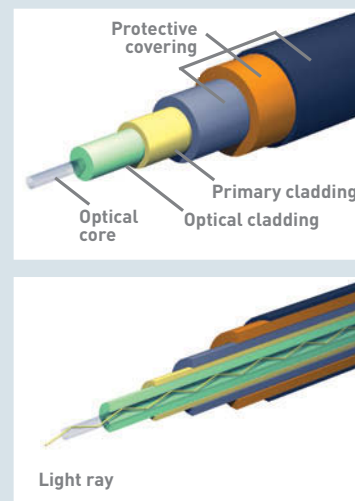

ADVANTAGES

- Most reliable and secure transmission method
- Very high data transmission speed, up to 100 Gb/s
- Low signal reduction: supports transmission over long distances (multi-mode fiber)
- Immunity against electromagnetic interference
- No electromagnetic radiation
- Discrete, 100% secure link
- Corrosion resistance

Copper Data Cables

The development of communications cable technology is rapidly changing and the use of high-speed networks is growing exponentially. CABLOFIL® has become accepted as the ideal support for copper communication cables (coaxial cables and twisted pairs).

NEW STANDARDS FOR NEW PERFORMANCE

The category characterizes the performance level of a single component, such as a cable, connector or even a lead. For example, a cable will be stamped "Cat. 6" if it passes the tests required for Category 6 approval.

The class characterizes the performance level of a combination involving more than one component (e.g. cable + connector). As such, the class defines the performance level of an installation rather than providing information on a component.

Category	Class	Throughput	Frequency
Cat. 5	D	≤ 100 Mbits/s	100 Mhz
Cat. 5e	D	≤ 100 Mbits/s	155 Mhz
Cat. 6	E	≤ 1 Gbit/s	250 Mhz
Cat. 6a	Ea	≤ 10 Gbits/s	500 Mhz
Cat. 7	F	≤ 10 Gbits/s	600 Mhz
Cat. 7a	Fa	≤ 10 Gbits/s	1000 Mhz

When compiling specifications, it is best to specify the desired application class as well as the category of the components to be installed.

COAXIAL CABLE

Low-cost and easy to manipulate, screened coaxial cables are used in data, industrial and instrumentation applications to transmit fast digital signals at low level.

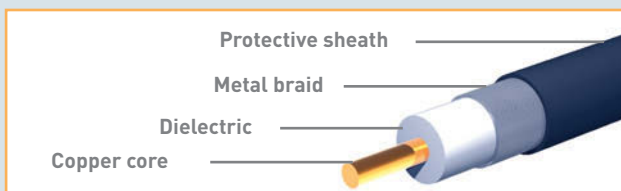

TWISTED PAIR

This type of cable is most commonly used for telephone and data applications in local area networks. The pairs, two intertwined copper wires, are insulated from each other by plastic and enclosed in a sheath.

U/UTP Unshielded Twisted Pair:

Unshielded twisted pairs in an unscreened sheath.

The most widely used around the world and also the cheapest.

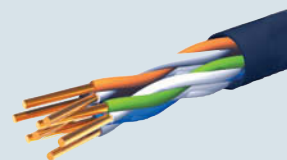

F/UTP Foiled Twisted Pair:

Twisted pairs in a screened sheath. Mostly used in France.

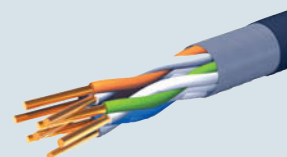

S/FTP or S-STP Screened Shielded Twisted Pair:

Screened twisted pairs in a screened sheath. Mainly used in Germany.

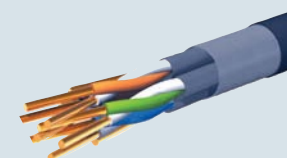

The screening of FTP and SFTP cables will only be effective against electromagnetic interference if both ends are connected to earth.



RELIABILITY AND DURABILITY

The two major considerations for the network infrastructures are the reliability and durability of the installation. In order to measure the positive contribution made by CABLOFIL[®], even when overloaded with cables, a series of independent tests were carried out.

> Independent tests

The aim is to develop a detailed understanding of the short-term or long-term benefits of using CABLOFIL, as opposed to conventional flat-bottomed supports, for Cat. 5e and Cat. 6 cables. CABLOFIL had its cable trays tested by Intertek Testing Services, a division of ETL, the world's leading provider of testing, inspection and certification services.

> Measurements

For the two tests described below, parameters relating to cable characteristics (NEXT, FEXT, Attenuation Return Loss, etc.) are measured in different configurations. The main parameter selected for comparison purposes is Return Loss. The aim is to define a cable's impedance regularity. Each irregularity causes the signal to return to its source.

> Test for reliability under load

90 meters of Cat. 5e and Cat. 6 cables are tested with no load, before being subjected to mechanical stress equivalent to the weight of 40 cables stacked together. Measuring and comparing the Return Loss for each configuration determines the effect of the support.

Results:

The tests show that, for a Category 5e or Category 6 cable subjected to a load of 40 cables, there is no significant difference in behavior between CABLOFIL cable tray and a support with a flat base.

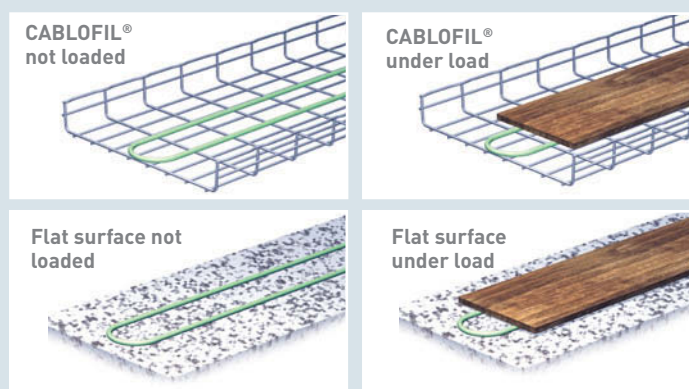

> Test of durability under load

In order to establish how data cable installations change over time, the equipment is subjected to a simulated 15-year aging process based on extremely stringent military standards and the same tests are performed. The cables and supports undergo 200 cycles over large temperature variations (-40°F to 185°F) over a period of 2 weeks.

Results:

The cable supported by CABLOFIL, an open and ventilated system, performs better than a closed system with a flat-bottom which does not allow heat to dissipate.

If you would like more details on these results, please contact our technical support service.

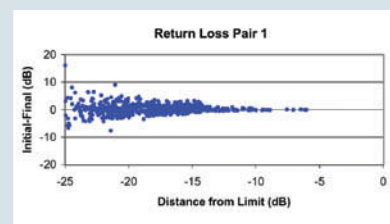
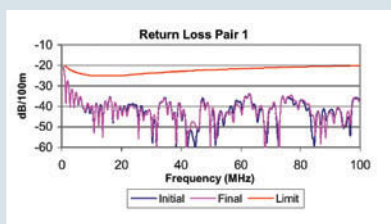

Standards and Directives

The manufacture and use of cable trays are subject to strict and precise regulations. CABLOFIL[®] gives an update on the applicable texts and ensures its products are compliant.

DIFFERENCE BETWEEN A DIRECTIVE AND A STANDARD

A directive defines the requirements related to the effects of the products on property and people, but it does not explain in direct terms how to comply: this is the function of standards.

DIRECTIVES

The following directives apply directly to cable trays:

- The Low Voltage Directive 2006/95/EC, referred to as the "LVD", previously 73/23/EEC
- The 93/68/EEC Directive, referred to as "CE Marking"

> The "CE Marking" Directive

The 93/68/EEC Directive, known as the "CE Marking" Directive, modifies the Low Voltage Directive as far as procedures relating to assessment and conformity marking are concerned.

THE RoHS DIRECTIVE

The 2002/95/CE Directive (Restriction of Hazardous Substances), referred to as RoHS, aims to restrict the use of six hazardous substances (lead, mercury, cadmium, hexavalent chromium, polybrominated biphenyls (PBB) and polybrominated diphenyl ethers (PBDE)). It came into effect on the 1st of July, 2006.

Although cable trays are exempt from the scope of this directive, CABLOFIL products contain none of the substances targeted by this directive.

> The EMC Directive 89/336/EEC, repealed by the 2004/108/EC Directive

The EMC Directive 2004/108/EC applies exclusively to active components (i.e. those carrying a current or subject to a voltage).

Cable trays, which are by definition passive components, are therefore unaffected by this directive.

When correctly connected to the earth network, the metallic cable tray plays a positive role in terms of an installation's EMC.



STANDARDS

The NEMA VE standard, "Cable tray systems and cable ladder systems for electrotechnical installations", defines the characteristics of cable trays.

> The NEMA VE standard

This standard defines configurations for the mechanical tests to be performed on cable trays, brackets, hangers and other accessories. It also specifies the requirements and methods for the electrical continuity tests which cable trays and couplers must meet.



All the mechanical and electrical performance levels of the CABLOFIL® range are tested according to the methods described by this standard.

CE MARKING

The NEMA VE standard for cable trays is the "product" standard which defines the requirements and tests for cable tray and cable ladder systems. As IEC 61 537 is the only harmonized standard at a European level, it is the reference when marking CE on the products, as requested in the LVD.

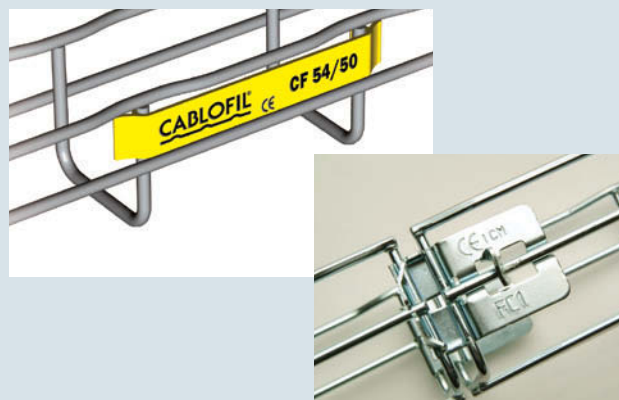

Currently, all CABLOFIL cable trays and accessories comply with European standards. The products are therefore marked with the **CE** logo.

CERTIFICATIONS FOR CABLOFIL®



Fire Resistance

Safety is a major concern for everyone, but can only be achieved with knowledge of how electrical equipment behaves in the event of a fire. CABLOFIL® has been successfully tested and proven to meet all fire-safety requirements.

STANDARD DIN 4102-12

The German standard serves as a reference. There is still no European standard on fire resistance specifically for cable trays. The German standard specifies that the entire system of cable trays, accessories and cables must be tested in an oven which is at least 3 m long for a period of 30, 60 or 90 minutes at temperatures of up to 1000°C (1832°F).



Period	Certification
> 30 minutes	E 30
> 60 minutes	E 60
> 90 minutes	E 90

The test aims to verify whether the electrical system is working properly and make sure that sources of critical data (emergency lighting, ventilators, emergency exit, fire alarm, etc.) can resist long enough to provide assistance in the event of a fire. The test also proves system integrity to reduce impediments for fire protection personnel. The tray must be able to remain secured to the ceiling and keep both cable and structure from falling, which could block fire fighters' means of egress. Aluminum cable tray products cannot contain cables in event of a fire.

TEST CONFIGURATION

CABLOFIL standard products passed the tests without the need to develop an extensive or specific range. The configurations used by CABLOFIL involve wire cable trays with two different spans (50" and 60") subject to a maximum permissible load of between 2 lbs/ft and 13.5 lbs/ft. The increase in temperature follows the temperature curve (ETK) defined by DIN 4102-12.

The E90 test does not in itself validate a wire cable tray, but validates the combination of CABLOFIL with a specific type of cable. This underlines the complexity, as well as the relevance, of these tests, which have already been passed by a number of cable types. Cables are tested in pairs.

The surprising appearance of the cable tray after the test is quite normal. The mechanical properties of the cables and cable tray are impaired but they achieved their objective: to ensure the durability of the installation for a given period.

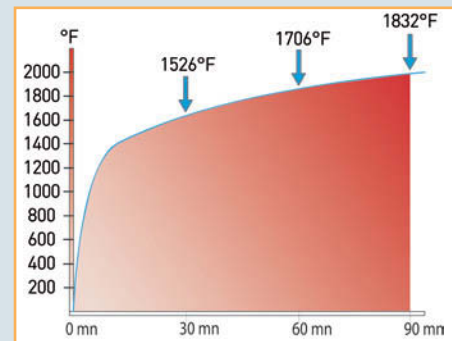

RECOGNIZED INDEPENDENT LABORATORIES

The IBMB (Institut für Baustoffe, Massivbau & Brandschutz) and FIRES laboratories are recognized centers for testing and issuing the associated certificates. They ensure that the test conditions described in the standard DIN 4102-12 are observed.

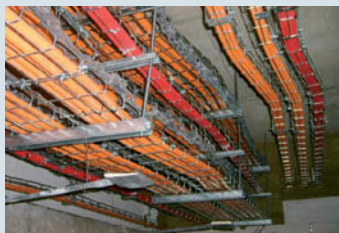

Before test



During test



After test

CABLOFIL® is certified to E90 for a number of configurations that meet the requirements of data transfer facilities designed to ensure the protection of property and people in the event of a fire. Below are 9 representative samples of the more than 20 configurations tested.

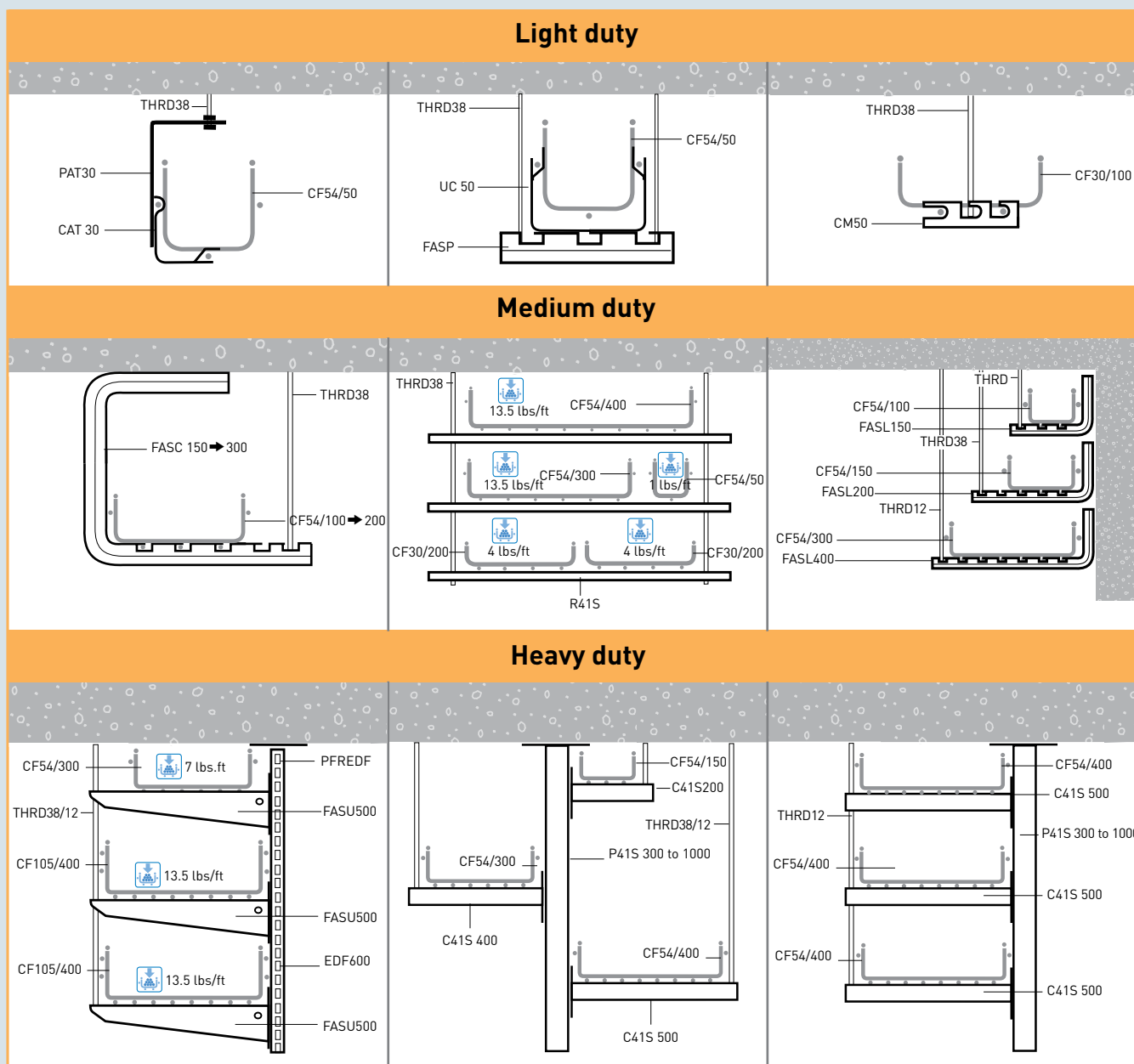

Fire Protection

FLAMESTOPPER™

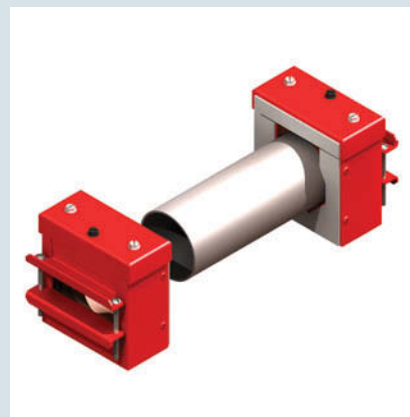
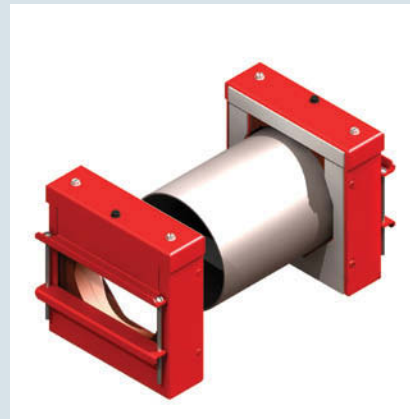
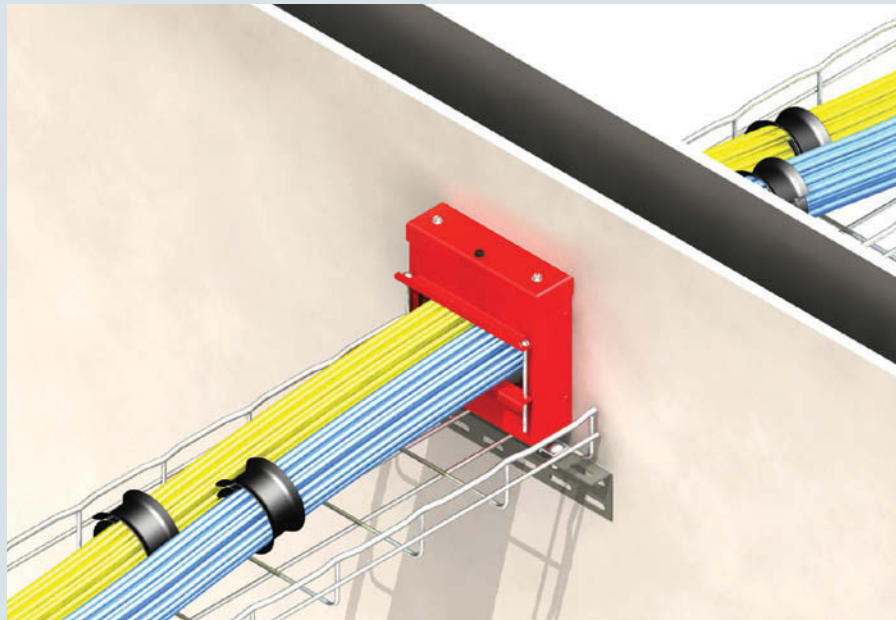

If you need the integrity of a firewall, without adding caulk or putty after the cables have been installed, look to FlameStopper thru-wall fittings. Redesigned for both new installations and retrofits, these fittings combine a built-in fire-stopping intumescent material with an enclosed thru-wall penetration. They meet UL tests for flame, temperature and smoke, as well as for use in air handling spaces (plenums) Once installed, FlameStopper fittings allow you to add or remove cables easily, without risking unseen and potentially dangerous gaps or voids that can occur with calks or putty.

FlameStopper thru-wall fittings consist of two box assemblies, each with adjustable steel doors. The boxes are fitted to EMT conduit and cable pass through a block of intumescent material inside each assembly. At 375° the material expands, creating a hard char that fills voids around the cables and stops flame from penetrating the opening. FlameStopper thru-wall fittings are easy to install and inspect and work seamlessly with Legrand/Cablofil cable management products.

- Available in 2" and 4" capacities.
- 4 hour rating for flame and temperature when tested to UL 1479 standards.
- Highly effective smoke stop.
- Can be ganged for additional capacity.
- Bond both FlameStopper Fittings and Cable Trays together by attaching proper size wire to ground screw on fitting tops, through FlameStopper Sleeve, and to trays using either Cablofil GNDSB or GNDCL ground clamp in order to comply with NEC 250.96.

TO INSTALL FLAMESTOPPER



1 Determine the location for the fitting on the wall and cut a hole to fit FlameStopper EMT conduit.



2 Install FlameStopper box to one side of the wall using adhesive strips. Insert the proper length of conduit thru the opening and press in place.



3 Install the second FlameStopper box to opposite side of the wall and tighten all bolts.

Firestop 4" Trade EMT Conduit Fitting

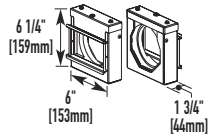

For transitioning cable through fire rated walls/floors for both new and retrofit applications. Available in red (RED), or G90 galvanized finish (GA). UL System W-L-3264 and W-J-3137.

Firestop 2" Trade EMT Conduit Fitting

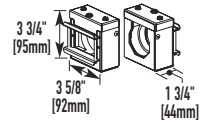

For transitioning cable through fire rated walls/floors for both new and retrofit applications. Available in red (RED), or G90 galvanized finish (GA). UL System W-L-3264 and W-J-3137.

	DEPTH		WIDTH		HEIGHT		RED	GA
	INCHES	MM	INCHES	MM	INCHES	MM		
FS2R	1.75"	44	3.625"	92	3.75"	95	FS2R-RED	RS2R-GA

Precut Conduit 4" Trade Size EMT

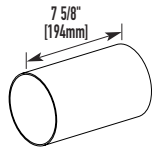

Precut to 7 5/8" [194mm] to fit standard gypsum fire walls with a two-hour fire rating (6" [152mm] wall thickness).

Precut Conduit 2" Trade Size EMT

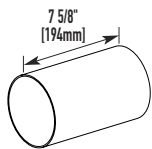

Precut to 7 5/8" [194mm] to fit standard gypsum fire walls with a two-hour fire rating (6" [152mm] wall thickness).

Heat Shield 4" Trade Size Conduit

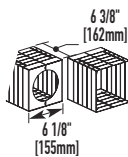

Used only when an existing installed conduit extends 1" [25mm] to 6" [152mm] beyond the wall surface.

Heat Shield 2" Trade Size Conduit

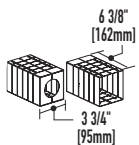

Used only when an existing installed conduit extends 1" [25mm] to 6" [152mm] beyond the wall surface.

Retrofit Kit for Existing Installations

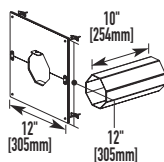

Kit includes 4" trade size split conduit sleeve to enclose existing cables, and 12" x 12" [305mm x 305mm] ceramic heat protected wall plate to cover irregular hole cuts. For use with FS4R Series Firestop.

Retrofit Kit for Existing Installations

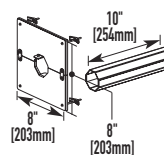

Kit includes 2" trade size split conduit sleeve to enclose existing cables, and 8" x 8" [203mm x 203mm] ceramic heat protected wall plate to cover irregular hole cuts. For use with FS2R Series Firestop.

References

SELECTED REFERENCES

> Service sector

Manchester Royal Infirmary – England
IKEA, Auchan, HSBC, BNP Paribas
World Trade Center, Brussels – Belgium
Dell Call Center, Edmonton – Canada
Sheraton Hotel, Burj Dubai Tower
Saint Louis University – USA

> Heavy industry

Black Thunder coal mine – USA
Wolverine Tubes factory – Canada
Cemex factory, Italcementi
Lukoil – Russia
Noble Drilling Services – Singapore
Meridien Solar Energy Park, Siemens Wind Power

> Infrastructure

T2, Mexico DF Airport – Mexico
Rome Train Station – Italy
Underground rail tunnels, Sydney – Australia
Zhivopisny Bridge, Moscow – Russia
King’s Dock Arena, Liverpool – England
Deutsche Telekom, Telmex

> Processing industries

Bayer Healthcare, Sanofi Aventis
Ford/Magna Corp, Bombardier Transportation
Nestlé, Danone, Unilever, Masterfoods
Chantiers de l’Atlantique – France
Gdansk shipyard – Poland
MT MembraTec – Denmark

IN CABLOFIL® THEY TRUST

Heathrow Airport, England, Terminal 5 (T5)

Terminal 5, which houses all of British Airways operations, has three satellites. These required more than 500 km of CABLOFIL cable trays to be installed from the public areas, technical areas, baggage conveyance areas and underground rail tunnels.

“Continuous improvements in quality can only be achieved if we are prepared to try new approaches. We will always use those products which create the most value for the customer”, says Ron Haldane, who is responsible for quality assurance and continuous improvement at Amec Building and Facilities Services.



No Room for Conduit at Las Vegas Dewatering Facility

Cablofil was used to fit a mountain of cables into a new dewatering facility in Las Vegas that allows water to be reclaimed from the sewage treatment process and return it to the environment.

Conduit was specified for the project, but the contractor needed a different way to support the myriad of control, signal and power cables. The project manager was quoted, “There were no straight long runs anywhere in the facility, with Cablofil tray, we would be able to construct the cable pathway to fit the facility and put in turns and changes in levels wherever needed.”

In many places, the tray was installed in three tiers—with signal, control and power cables each on a separate level to keep the pathway as compact and efficient as possible.



Decision-Making Software

CABLOFIL® has developed 3 types of decision-making software to guide users throughout every stage of the process, from design through the creation of the bills of material.

- CABLOCAD: to help design installations
- CABLOSOFT: to recommend a solution
- e-CATALOGUE: to put together a technical specification and generate a request for quotation

CABLOCAD

CABLOCAD is a plug-in for all versions of AUTOCAD®. It is a comprehensive resource containing all the CABLOFIL solutions and can be used to create a picture of the cable routing solution along with detailed information. It also has the facility to integrate this solution into the wider design of the building and generates a detailed list of the products required (including quantities).

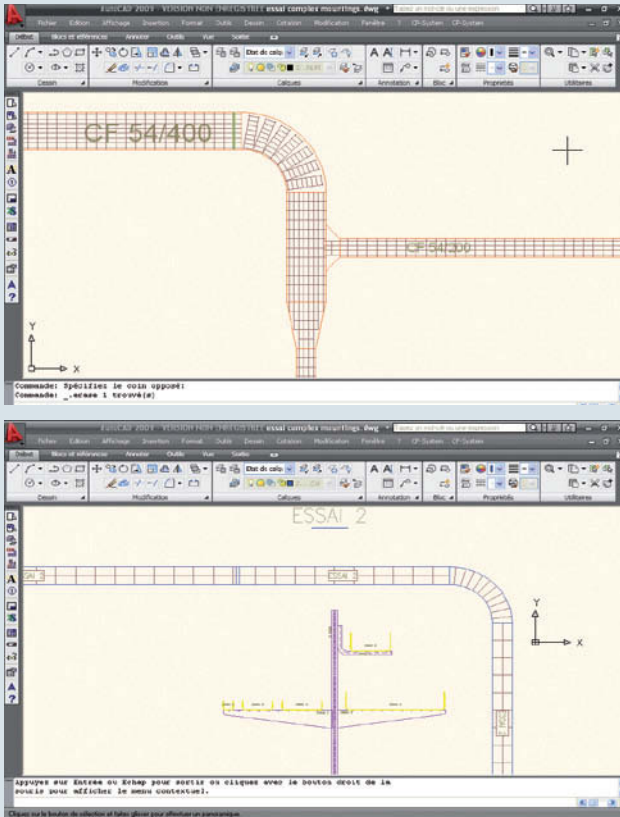

CABLOSOFT

CABLOSOFT software makes recommendations to help ensure the right products are chosen and get the most out of them in terms of the cable routes at hand and the associated technical demands. It generates a full list of products to be used for each section of the cable routes.

All of our softwares can be downloaded for free from www.cablofil.com.

e-CATALOGUE

CATALOGUE brings together all the products and gives all the technical information required. Once the products have been selected and the quantities specified, a technical specification is automatically generated, along with a quantitative description, which can be sent off for quotation.

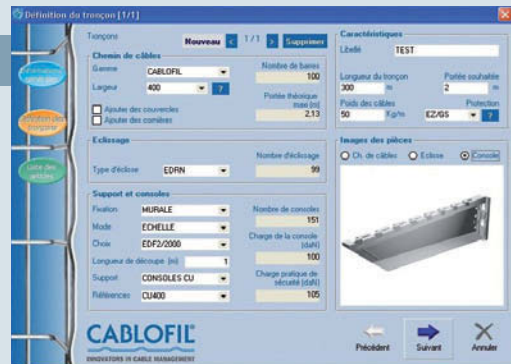
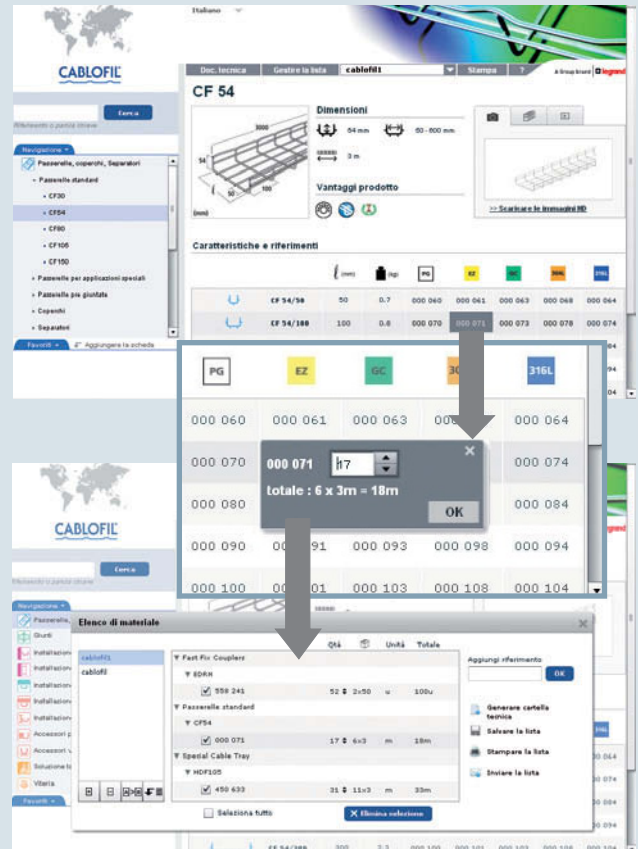

Specifications for Power and Data Cable Supports

SECTION 260536 (16139) - CABLE TRAYS

PART 1 - GENERAL

Specifier Note: Section numbers and titles are from *MasterFormat 2004 Edition* with numbers and titles from *MasterFormat 1995 Edition* as well.

1.1 SECTION INCLUDES:

- A. Continuous, rigid, welded steel or stainless steel wire mesh cable management system.
- B. Cable tray systems are defined to include, but are not limited to, straight sections, supports and accessories.

1.2 RELATED DOCUMENTS:

- A. Drawings and general provisions of the Contract, including General and Supplementary Conditions and Division 1 Specification Sections, apply to this Section.

1.3 SUMMARY

- A. Related Sections include the following:
2004 Edition

- 1. Section 26 05 13 - Medium-Voltage Cables.
- 2. Section 26 05 19 - Low-Voltage Electrical Power Conductors and Cables.
- 3. Section 26 05 23 - Control-Voltage Electrical Power Cables.
- 4. Section 26 05 33 - Raceway and Boxes for Electrical Systems.
- 5. Section 27 05 28.36 - Cable Trays for Communications Systems.
- 6. Section 27 10 00 - Structured Cabling.
- 7. Section 28 05 13 - Conductors and Cables for Electronic Safety and Security.
- 8. Section 28 05 28.36 - Cable Trays for Electronic Safety and Security.

1995 Edition

- 1. Section 16120 - Conductors and Cables.
- 2. Section 16130 - Raceway and Boxes.
- 3. Section 16140 - Wiring Devices.
- 4. Section 16150 - Wiring Connections.
- 5. Section 16200 - Electrical Power.
- 6. Section 16700 - Communications.

B. References:

- 1. IEC 61537 (2001) - Cable Tray Systems and Cable Ladder Systems for Cable Management
- 2. NEMA VE 1-2002/CSA C22.2 No. 126.1-02 - Metal Cable Tray Systems
- 3. ANSI/NFPA 70 (2005) - National Electrical Code (NEC)
- 4. TIA 569-A (1998) - Commercial Building Standard for Telecommunications Pathways & Spaces
- 5. ASTM A 510 - Specification for General Requirements for Wire Rods and Coarse Round Wire, Carbon Steel
- 6. ASTM A 380 - Specification for Standard Practice for Cleaning, Descaling, and Passivation of Stainless Steel Parts, Equipment, and Systems
- 7. ASTM B 633 - Specification for Electrodeposited Coatings of Zinc on Iron and Steel
- 8. ASTM A 123 - Specification for Zinc (Hot-Dip Galvanized) Coatings on Iron and Steel Products
- 9. ASTM A 653 - Specification for Steel Sheet, Zinc-Coated (Galvanized) by the Hot-Dip Process, Structural (Physical) Quality
- 10. Norm NF/A 91-131 for Galvanized Steel
- 11. Norm NF/EN 12-329 for Electro-zinc Coating
- 12. Norm NF/EN/ISO 14-61 for Hot-Dipped Galvanized Steel
- 13. Norm NF 10-088-2 for Stainless Steel

1.4 SUBMITTALS

- A. Comply with requirements of Section 01330 - Submittal Procedures.
- B. Product Data: Submit manufacturer's product data sheets for cable tray indicating dimensions, materials, and finishes, including UL Classification and NEMA/CSA Certification.
- C. Shop Drawings: Submit shop drawings indicating materials, finish, dimensions, accessories, layout, supports, splices, and installation details.
- D. Design Calculations: Verify loading capacities for supports.
- E. Coordination Drawings: Include floor plans and sections drawn to scale. Include scaled cable tray layout and relationships between components and adjacent structural and mechanical elements. Data presented on these drawings are as accurate as preliminary surveys and planning can determine. Field verification of all dimensions, routing, etc., is directed.
- F. Factory-certified test reports of specified products, complying with IEC 61537, NEC, and NEMA VE 1/CSA C22.2 No. 126.1.
- G. Submit manufacturer's certification indicating ISO 9001 quality certified.
- H. Submit training procedure for certifying cable tray installers.

1.5 QUALITY ASSURANCE

- A. Source Limitations: Obtain cable tray components through one source from a single manufacturer.
- B. Approval and Labeling: Provide cable trays and accessories specified in this Section that are approved and labeled.
 1. The Terms "Classified" pertaining to cable trays (rather than "Listed") and "Labeled": As defined in NFPA 70, Article 100.
 2. Listing and Labeling Agency Qualifications: A "Nationally Recognized Testing Laboratory" as defined in OSHA Regulation 1910.7.
- C. Comply with NFPA 70, National Electrical Code, Article 392: Cable Trays; provide UL Classification and labels.
- D. Comply with IEC 61537, Cable Tray Systems and Cable Ladder Systems for Cable Management.
- E. Comply with NEMA VE 1/CSA C22.2 No. 126.1, Metal Cable Tray Systems, for materials, sizes, and configurations; provide cCSAus Certificate and labels.
- F. Provide documentation of the following certifications:
 1. ISO 9001 quality certification.
 2. American Bureau of Shipping (ABS) Product Design Assessment certification.
 3. Det Norske Veritas (DNV) certification.
 4. E 90 Fire Testing certification.
 5. VDE certification.
- G. Provide ETL test documentation showing cable compression/ deformation testing.
- H. Provide military test documentation showing compliance with the following standards:
 1. MIL-S-901D (Navy) –Military Specification, Requirements for Shock Tests, High Impact; Shipboard Machinery, Equipment and Systems
 2. MIL-STD-167-1 (Ships) – Military Standards Mechanical Vibrations of Shipboard Equipment

1.6 COORDINATION

- A. Coordinate layout and installation of cable tray with other installations.
 1. Revise locations and elevations from those indicated as required to suit field conditions and as approved by the Architect.
 2. Storage and Handling: Avoid breakage, denting and scoring finishes. Damaged products will not be installed. Store cable trays and accessories in original cartons and in clean dry space; protect from weather and construction traffic. Wet materials will be unpacked and dried before storage.

PART 2 - PRODUCTS

2.1 MANUFACTURERS: Subject to compliance with requirements, provide products by the following:

A. Cablofil, Inc., 8319 State Route 4, Mascoutah, IL, 62258.
Phone: (618) 566-3230. Toll-Free: (800) 658-4641.
Fax: (618) 566-3250. Website: www.cablofil.com.
Email: info@cablofil.com.

- B. [Approved Alternates: Select one of the following, if applicable.]
 1. [Hoffmann]
 2. [P-W Industries]
 3. [Black Box Corporation]
 4. [Code Electric]

2.2 MATERIALS AND FINISHES:

A. Cable Tray Materials: select one of the following:

1. [Carbon steel wire, ASTM A 510, Grade 1008. Wire welded, bent, and surface treated after manufacture.]

OR

2. [Stainless steel wire, AISI 304L or AISI 316L, 2B, finished cold drawn wire.]

B. Cable Tray Finishes:

1. Finish for Carbon Steel Wire after welding and bending of mesh; select one of the following:
 - a. [Electrodeposited Zinc Plating: ASTM B 633, Type III, SC-1.]
 - b. [Hot-Dip Galvanizing After Fabrication: ASTM A 123.]
 - c. [Powder-Coated:]
 - 1) [Black powder-coated surface treatment over Electrodeposited Zinc Plating using ASA 61 black polyester coating.]
 - 2) [Custom Color Powder-Coated surface treatment over Electrodeposited Zinc Plating. Contact Cablofil for color information.]

2. Finish for Stainless Steel Wire: According to ASTM B 380.

C. Cable tray will consist of continuous, rigid, welded steel wire mesh cable management system, to allow continuous ventilation of cables and maximum dissipation of heat, with UL Classified splices where tray acts as Equipment Grounding Conductor (EGC). Wire mesh cable tray will have continuous Safe-T-Edge T-welded top side wire to protect cable insulation and installers.

D. Provide splices, supports, and other fittings necessary for a complete, continuously grounded system.

1. Mesh: 2 x 4 inches (50 x 100 mm).
2. Straight Section Lengths: 118 inches (3,000 mm).
3. Wire Diameter: Patented design includes varying wire sizes to meet application load requirements; to optimize tray strength; and to allow tray to remain lightweight.
4. Safe-T-Edge: Patented Safe-T-Edge technology on side wire to protect cable insulation and installers' hands.

Cablofil

SECTION 260536 (16139) - CABLE TRAYS (...CONTINUED)

5. Fittings: Wire mesh cable tray fittings are field-fabricated from straight tray sections, in accordance with manufacturer's instructions and Item 2.3.
 6. CF Series Cable Tray Size:
 - a. Depth: Cable tray depth will be (unless otherwise shown on drawings):
 - 1) [1 inch (30 mm)]
 - 2) [2 inches (54 mm)]
 - 3) [4 inches (105 mm)]
 - 4) [6 inches (150 mm)]
 - b. Width: Cable tray width will be (unless otherwise shown on drawings):
 - 1) [2 inches (50 mm)]
 - 2) [4 inches (100 mm)]
 - 3) [6 inches (150 mm)]
 - 4) [8 inches (200 mm)]
 - 5) [12 inches (300 mm)]
 - 6) [18 inches (450 mm)]
 - 7) [20 inches (500 mm)]
 - 8) [24 inches (600 mm)]
 - c. Length: Cable tray section length will be 118 inches (3000mm) unless otherwise shown on drawings.
 - d. Fill Ratio: Cable tray may be filled to [40%] [50%] [60%] [100%] of total fill capacity. Size cable tray to accommodate future cabling changes or additions.
 - e. Load Span Criteria:
 - 1) Install and support cable management system in accordance with one of the following:
 - a) [IEC 61537, with load span criteria of L/200 (to exceed standard requirements of L/100) and a Safety Factor of 1.7]
- OR**
- b) [NEMA VE-1 (2002), with Safety Factor of 1.5]
 - 2) Cable tray will be capable of carrying a uniformly distributed load of _____ pounds per foot on a _____ support span, according to load tests of standard shown in Item A above.
7. Other cable tray options; select if applicable:
 - a. [Cablofil Easy Pack: Ready-to-install 78" (2000mm) lengths of CF Series Cable Tray with Preclick Splices and all associated hardware.]
 - b. [CFG Series: G-shaped cable tray for direct attachment or for use in small spaces.]
 - c. [FCF Fasclis Series: CF Series Cable Tray with pre-mounted fast splice.]
 - d. [CFL Series: CF Series Cable Tray with one bend for beam attachment.]
 - e. [Telex Rail: TXF Series Cable Tray; cover and supports also available.]

2.3 CABLE TRAY SUPPORTS & ACCESSORIES

- A. Fittings/Supports: Wire mesh cable tray fittings are field-fabricated from straight tray sections, in accordance with manufacturer's instructions. Supports will include the FAS (Fast Assembly System) where possible so that screws, bolts, and additional tools are not required for cable tray mounting; installation time is reduced; and tray path can adapt to installation obstacles without the need for additional parts. Place supports so that support span does not exceed that shown on the drawings.
 1. Ceiling-mounted supports mount to ceiling structure directly or with ¼", 3/8" or ½" threaded rod.
 2. Wall-mounted supports.
 3. Underfloor supports mount directly to floor or to floor posts.
 4. Splices, including those approved for electrical continuity (bonding), as recommended by cable tray manufacturer.
 5. Accessories: As required to protect, support, and install a cable tray system.

2.4 EQUIPMENT GROUNDING CONDUCTOR FUNCTION & GROUNDING

- A. UL Classified cable trays may act as Equipment Grounding Conductors. Contact Cablofil for approved sizes.
 1. Use UL Classified splicing methods as recommended by Cablofil.
 - a. Ground cable trays at end of continuous run.
 - b. Ground continuous cable tray runs every 60 feet.
 2. Cable trays that are not UL Classified will be grounded per NEC requirements and manufacturer recommendations.
 - a. Ground cable trays against fault current, noise, lightning, and electromagnetic interference by mounting grounding wire to each 10' cable tray section with grounding clamp, Cablofil Model GNDCL.

PART 3 - EXECUTION

3.1 EXAMINATION

- A. Examine substrates for compliance with requirements for installation tolerances and other conditions affecting performance of cable trays. Do not proceed with installation until unsatisfactory conditions have been corrected.

3.2 INSTALLATION

- A. Install cable tray level and plumb according to manufacturer's written instructions, Coordination Drawings, original design, and referenced standards.
 - 1. Cutting: Field-fabricate changes in direction & elevation by cutting & bending cable tray.
 - a. Cut cable tray wires in accordance with manufacturer's instructions.
 - b. Cable tray wires must be cut with side-action bolt cutters with offset head to ensure integrity of protective galvanic layer.
 - c. Remove burrs and sharp edges from cable trays.
 - 2. Certified Installers: Cable tray installers must have successfully completed Cablofil's Certified Installer program.

END OF SECTION 260536 (16139)

designed to be better.



Cablofil

www.legrand.us/cablofil

Phone 800-658-4641

618-566-3230

Fax 618-566-3250

8319 State Route 4

Mascoutah, IL 62258 USA